

# 积层带导线陶瓷电容器

(支持无卤素、车载等级)

## FA系列

Type:	引线间距	5.0 mm FA28 [4.0x5.5mm] FA24 [4.5x5.5mm] FA26 [5.5x6.0mm] FA20 [5.5x7.0mm] FA22 [7.5x8.5mm] FA23 [8.5x11.0mm]
	引线间距	2.5 mm FA18 [4.0x5.5mm] FA14 [4.5x5.5mm] FA16 [5.5x6.0mm] FA11 [5.5x7.0mm]

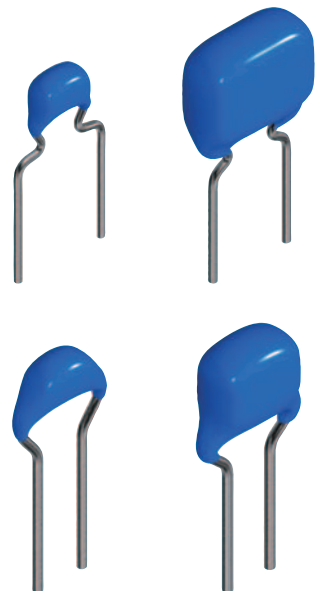

## 使用注意事项

在使用本产品前，请务必随附采购规格书。

## 安全注意事项

使用本产品时，请注意安全事项。

### ⚠ 注意

1. 本目录中的产品，被装载到汽车上或车载产品，按照本目录中记载的范围、条件，可使用在汽车标准用途中。另外，包含本产品的该汽车或车用产品，应以通常的操作、使用方法来运用。汽车以外、对于需要高度安全性和可靠性的，或者设备的故障，误动作，运转不良可能会给人的生命，身体及财产等造成损害，以及有可能产生莫大社会影响的以下用途（以下称‘特定用途’）中的适用性，性能发挥，品质，本公司不予保证。

因用于超过本目录所规定的范围、条件，或用于其他特定用途而产生损失、伤害等情况，我司恕不承担责任，请谅解。客户预定在本产品目录的范围，条件之外，或者在特定用途中使用，请事先咨询本公司相关部门。本公司会配合客户需求，一起协商不同于本产品目录中所记载的使用用途。

- |                            |                    |
|----------------------------|--------------------|
| (1) 航空，航天设备                | (8) 公共性的高度信息处理设备   |
| (2) 运输设备（电车，船舶等）           | (9) 军用设备           |
| (3) 医疗设备（除《药事法》分类中的Ⅰ、Ⅱ级以外） | (10) 电热用品，燃烧设备     |
| (4) 发电控制设备                 | (11) 防灾防盗设备        |
| (5) 原子能（核能）相关设备            | (12) 各种安全装置        |
| (6) 海底设备                   | (13) 其他被认定为特定用途的用途 |
| (7) 交通工具控制设备               |                    |

此外，在对使用本产品的设备进行设计时，请根据该设备的使用用途及状态确保保护电路及装置，并设置备份电路。

另外，虽然本产品目录中记载的产品是设想在上述汽车或车用产品上使用的，但我们也不会禁止其使用在不要求类似汽车等级的高安全性和信赖性，或对生命、身体、财产，及对社会造成影响较小的一般电子设备的应用情形。因此，本产品目录中记载的产品可应用一般电子设备的通用标准，当以通常的操作、使用方法来使用一般电子设备时，关于其使用也适用本共通使用注意事项。

2. 本产品目录中记载的产品因改良及其他原因可能在不经预告的情况下进行变更或停止供应。
3. 关于本产品目录中记载的产品，本公司备有记载了各产品的规格及安全注意事项的“交货规格书”。在选用产品时，建议签定交货规格书。
4. 在出口本产品目录中记载的产品时，有时会被归为“外汇及外贸管理法”中规定的管制货物等。在这种情况下，需要有依据该法规定的出口许可。
5. 关于本产品目录的内容，未经本公司许可不得擅自转载或复制。
6. 因使用本产品目录中记载的产品而发生涉及本公司或第三者的知识产权及其他权利的问题时，本公司对此将不承担责任。并且，本公司不对该等权利的实施权办理许可。
7. 本产品目录适用于从本公司或本公司的正规代理商购买的产品。从其他第三者购买的产品不在适用范围之内。

# 积层带导线陶瓷电容器

## 支持无卤素、车载等级

RoHS指令对应产品  
无卤素

## FA系列的概要

### ■特点

- 额定电压25V~630V、静电电容1pF~22 $\mu$ F的充实的产品阵容
- 符合AEC-Q200标准

### ■用途

- 车载用各种马达的噪音对策
- 遥控车门开关等谐振电路
- 开关电源等的旁路电容器、平滑电容器等
- 缓冲电路
- PFC输入滤波器

### ■型号的命名方法

FA	2	8	C0G		1H		010		C	□□□	□	
系列名称	引线间距 (mm)	LxWxT 尺寸 (mm)		电容 温度特性		额定电压 (V)		公称电容 (pF)		电容容差	弊社内部 管理记号	包装形式
	1   2.5	8   4.0x5.5x2.5	C0G	0 $\pm$ 30ppm/ $^{\circ}$ C		1E   25	010	1		C	$\pm$ 0.25pF	0   散装品
	2   5.0	4   4.5x5.5x3.0	X7R	$\pm$ 15%		1H   50	100	10		D	$\pm$ 0.5pF	6   编带
		6   5.5x6.0x3.5	X7S	$\pm$ 22%		2A   100	101	100		J	$\pm$ 5%	
		0   5.5x7.0x4.0	X7T	+22, -33%		2E   250	102	1,000		K	$\pm$ 10%	
		1   5.5x7.0x4.0				2W   450				M	$\pm$ 20%	
		2   7.5x8.5x4.5				2J   630						
		3   8.5x11.0x5.5										

### ■温度范围

电容温度特性	温度范围*	
	工作温度 ( $^{\circ}$ C)	保存温度** ( $^{\circ}$ C)
C0G, X7R, X7S, X7T	-55 to +125	-55 to +125

\* 电容器自身的发热温度不超过 20 $^{\circ}$ C, 包括这个温度在内。

\*\* 保存温度范围以固定基板后为准。

○ RoHS指令对应产品：详细内容查看这里。 <https://product.tdk.com/info/zh/environment/rohs/index.html>

○ 无卤素：指的是Cl含量不到900ppm、Br含量不到900ppm以及Cl、Br的合计含量不到1500ppm。

⚠ 为了能够更加正确、安全地使用产品，请务必索取能进一步确认详细特性、规格的采购规格书。  
记载内容可能因为产品改良等原因不经预告而更改，恕不另行通知。

## FA系列的概要

### ■ 包装数量

型	包装数量	
	编带 (个 / 箱)	散装品 (个 / 包)
FA28	2000	500
FA24	2000	500
FA26	2000	500
FA20	1500	500
FA22	1000	500
FA23	1000	200
FA18	2000	500
FA14	2000	500
FA16	2000	500
FA11	1500	500

### ■ 推荐流量温度曲线图

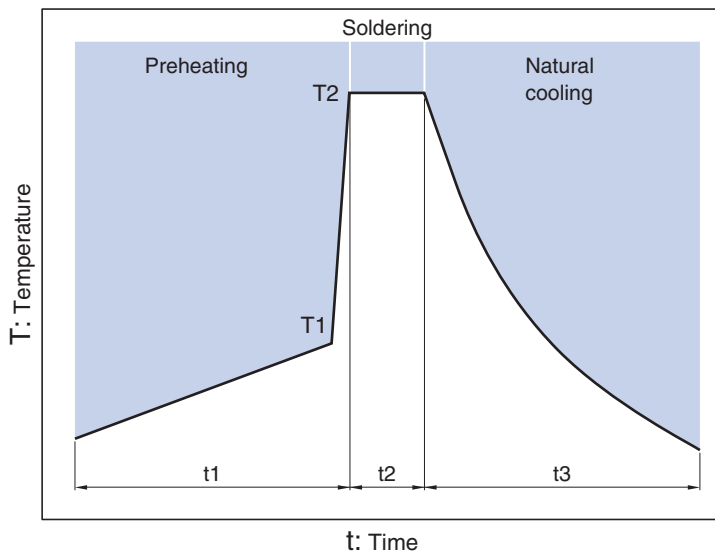

Preheating		Peak		Natural cooling
Temp.	Time	Temp.	Time	Time
T1	t1	T2	t2	t3
110°C min.	Over 60s.	260°C	Within 5s.	Over 60s.

## FA28型

## ■形状与尺寸

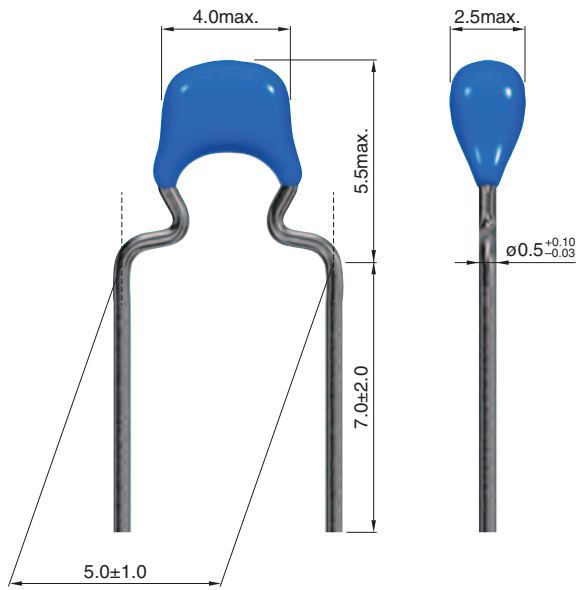

Dimensions in mm

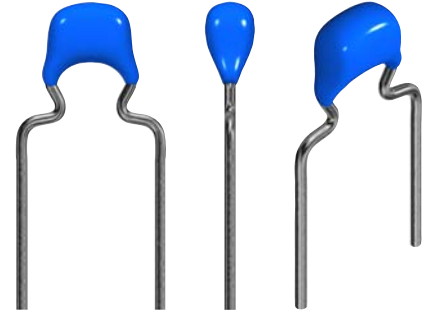

## FA28型

## ■ 电气特性

## □ 特点规格表

种类1 (温度补偿用)

温度特性	电容	容差	额定电压 Edc (V)	型号*
C0G	1.0pF	±0.25pF	50	FA28C0G1H010CNU0□**
C0G	1.5pF	±0.25pF	50	FA28C0G1H1R5CNU0□
C0G	2.2pF	±0.25pF	50	FA28C0G1H2R2CNU0□
C0G	3.3pF	±0.25pF	50	FA28C0G1H3R3CNU0□
C0G	4.7pF	±0.25pF	50	FA28C0G1H4R7CNU0□
C0G	6.8pF	±0.5pF	50	FA28C0G1H6R8DNU0□
C0G	10pF	±0.5pF	50	FA28C0G1H100DNU0□
C0G	15pF	±5%	50	FA28C0G1H150JNU0□
C0G	22pF	±5%	50	FA28C0G1H220JNU0□
C0G	33pF	±5%	50	FA28C0G1H330JNU0□
C0G	47pF	±5%	50	FA28C0G1H470JNU0□
C0G	68pF	±5%	50	FA28C0G1H680JNU0□
C0G	100pF	±5%	50	FA28C0G1H101JNU0□
C0G	120pF	±5%	50	FA28C0G1H121JNU0□
C0G	150pF	±5%	50	FA28C0G1H151JNU0□
C0G	180pF	±5%	50	FA28C0G1H181JNU0□
C0G	220pF	±5%	50	FA28C0G1H221JNU0□
C0G	270pF	±5%	50	FA28C0G1H271JNU0□
C0G	330pF	±5%	50	FA28C0G1H331JNU0□
C0G	390pF	±5%	50	FA28C0G1H391JNU0□
C0G	470pF	±5%	50	FA28C0G1H471JNU0□
C0G	560pF	±5%	50	FA28C0G1H561JNU0□
C0G	680pF	±5%	50	FA28C0G1H681JNU0□
C0G	820pF	±5%	50	FA28C0G1H821JNU0□
C0G	1nF	±5%	50	FA28C0G1H102JNU0□
C0G	1.2nF	±5%	50	FA28C0G1H122JNU0□
C0G	1.5nF	±5%	50	FA28C0G1H152JNU0□
C0G	1.8nF	±5%	50	FA28C0G1H182JNU0□
C0G	2.2nF	±5%	50	FA28C0G1H222JNU0□
C0G	2.7nF	±5%	50	FA28C0G1H272JNU0□
C0G	3.3nF	±5%	50	FA28C0G1H332JNU0□
C0G	3.9nF	±5%	50	FA28C0G1H392JNU0□
C0G	4.7nF	±5%	50	FA28C0G1H472JNU0□
C0G	5.6nF	±5%	50	FA28C0G1H562JNU0□
C0G	6.8nF	±5%	50	FA28C0G1H682JNU0□
C0G	8.2nF	±5%	50	FA28C0G1H822JNU0□
C0G	10nF	±5%	50	FA28C0G1H103JNU0□
C0G	1.0pF	±0.25pF	100	FA28C0G2A010CNU0□
C0G	1.5pF	±0.25pF	100	FA28C0G2A1R5CNU0□
C0G	2.2pF	±0.25pF	100	FA28C0G2A2R2CNU0□
C0G	3.3pF	±0.25pF	100	FA28C0G2A3R3CNU0□
C0G	4.7pF	±0.25pF	100	FA28C0G2A4R7CNU0□
C0G	6.8pF	±0.5pF	100	FA28C0G2A6R8DNU0□
C0G	10pF	±0.5pF	100	FA28C0G2A100DNU0□
C0G	15pF	±5%	100	FA28C0G2A150JNU0□
C0G	22pF	±5%	100	FA28C0G2A220JNU0□
C0G	33pF	±5%	100	FA28C0G2A330JNU0□
C0G	47pF	±5%	100	FA28C0G2A470JNU0□
C0G	68pF	±5%	100	FA28C0G2A680JNU0□
C0G	100pF	±5%	100	FA28C0G2A101JNU0□

\* 型号为本公司标准规格品。

\*\* 型号中的□输入包装代码0 (散装品包装) 或者6 (编带包装)。

## FA28型

## ■ 电气特性

## □ 特点规格表

种类1 (温度补偿用)

温度特性	电容	容差	额定电压 Edc (V)	型号*
C0G	120pF	±5%	100	FA28C0G2A121JNU0□**
C0G	150pF	±5%	100	FA28C0G2A151JNU0□
C0G	180pF	±5%	100	FA28C0G2A181JNU0□
C0G	220pF	±5%	100	FA28C0G2A221JNU0□
C0G	270pF	±5%	100	FA28C0G2A271JNU0□
C0G	330pF	±5%	100	FA28C0G2A331JNU0□
C0G	390pF	±5%	100	FA28C0G2A391JNU0□
C0G	470pF	±5%	100	FA28C0G2A471JNU0□
C0G	560pF	±5%	100	FA28C0G2A561JNU0□
C0G	680pF	±5%	100	FA28C0G2A681JNU0□
C0G	820pF	±5%	100	FA28C0G2A821JNU0□
C0G	1nF	±5%	100	FA28C0G2A102JNU0□
C0G	1.2nF	±5%	100	FA28C0G2A122JNU0□
C0G	1.5nF	±5%	100	FA28C0G2A152JNU0□
C0G	1.8nF	±5%	100	FA28C0G2A182JNU0□
C0G	2.2nF	±5%	100	FA28C0G2A222JNU0□
C0G	2.7nF	±5%	100	FA28C0G2A272JNU0□
C0G	3.3nF	±5%	100	FA28C0G2A332JNU0□
C0G	3.9nF	±5%	100	FA28C0G2A392JRU0□
C0G	4.7nF	±5%	100	FA28C0G2A472JRU0□
C0G	5.6nF	±5%	100	FA28C0G2A562JRU0□
C0G	6.8nF	±5%	100	FA28C0G2A682JRU0□
C0G	8.2nF	±5%	100	FA28C0G2A822JRU0□
C0G	10nF	±5%	100	FA28C0G2A103JRU0□
C0G	100pF	±5%	250	FA28C0G2E101JNU0□
C0G	120pF	±5%	250	FA28C0G2E121JNU0□
C0G	150pF	±5%	250	FA28C0G2E151JNU0□
C0G	180pF	±5%	250	FA28C0G2E181JNU0□
C0G	220pF	±5%	250	FA28C0G2E221JNU0□
C0G	270pF	±5%	250	FA28C0G2E271JNU0□
C0G	330pF	±5%	250	FA28C0G2E331JNU0□
C0G	390pF	±5%	250	FA28C0G2E391JNU0□
C0G	470pF	±5%	250	FA28C0G2E471JNU0□
C0G	560pF	±5%	250	FA28C0G2E561JNU0□
C0G	680pF	±5%	250	FA28C0G2E681JNU0□
C0G	820pF	±5%	250	FA28C0G2E821JNU0□
C0G	1nF	±5%	250	FA28C0G2E102JNU0□
C0G	1.2nF	±5%	250	FA28C0G2E122JNU0□
C0G	1.5nF	±5%	250	FA28C0G2E152JNU0□
C0G	1.8nF	±5%	250	FA28C0G2E182JNU0□
C0G	2.2nF	±5%	250	FA28C0G2E222JNU0□

\* 型号为本公司标准规格品。

\*\* 型号中的□输入包装代码 0 (散装品包装) 或者 6 (编带包装)。

## FA28型

## ■ 电气特性

## □ 特点规格表

种类2 (高介电率类)

温度特性	电容	容差	额定电压 Edc (V)	型号*
X7R	150nF	±10%	25	FA28X7R1E154KNU0□
X7R	680nF	±10%	25	FA28X7R1E684KRU0□
X7R	1uF	±10%	25	FA28X7R1E105KRU0□
X7R	1nF	±10%	50	FA28X7R1H102KNU0□
X7R	1.5nF	±10%	50	FA28X7R1H152KNU0□
X7R	2.2nF	±10%	50	FA28X7R1H222KNU0□
X7R	3.3nF	±10%	50	FA28X7R1H332KNU0□
X7R	4.7nF	±10%	50	FA28X7R1H472KNU0□
X7R	6.8nF	±10%	50	FA28X7R1H682KNU0□
X7R	10nF	±10%	50	FA28X7R1H103KNU0□
X7R	15nF	±10%	50	FA28X7R1H153KNU0□
X7R	22nF	±10%	50	FA28X7R1H223KNU0□
X7R	33nF	±10%	50	FA28X7R1H333KNU0□
X7R	47nF	±10%	50	FA28X7R1H473KNU0□
X7R	68nF	±10%	50	FA28X7R1H683KNU0□
X7R	100nF	±10%	50	FA28X7R1H104KNU0□
X7R	150nF	±10%	50	FA28X7R1H154KRU0□
X7R	220nF	±10%	50	FA28X7R1H224KRU0□
X7R	330nF	±10%	50	FA28X7R1H334KRU0□
X7R	470nF	±10%	50	FA28X7R1H474KRU0□
X7R	1nF	±10%	100	FA28X7R2A102KNU0□
X7R	1.5nF	±10%	100	FA28X7R2A152KNU0□
X7R	2.2nF	±10%	100	FA28X7R2A222KNU0□
X7R	3.3nF	±10%	100	FA28X7R2A332KNU0□
X7R	4.7nF	±10%	100	FA28X7R2A472KNU0□
X7R	6.8nF	±10%	100	FA28X7R2A682KNU0□
X7R	10nF	±10%	100	FA28X7R2A103KNU0□
X7R	15nF	±10%	100	FA28X7R2A153KNU0□
X7R	22nF	±10%	100	FA28X7R2A223KNU0□
X7S	33nF	±10%	100	FA28X7S2A333KRU0□
X7S	47nF	±10%	100	FA28X7S2A473KRU0□
X7S	68nF	±10%	100	FA28X7S2A683KRU0□
X7S	100nF	±10%	100	FA28X7S2A104KRU0□

\* 型号为本公司标准规格品。

\*\* 型号中的□输入包装代码 0 (散装品包装) 或者 6 (编带包装)。



# FA24型

## ■形状与尺寸

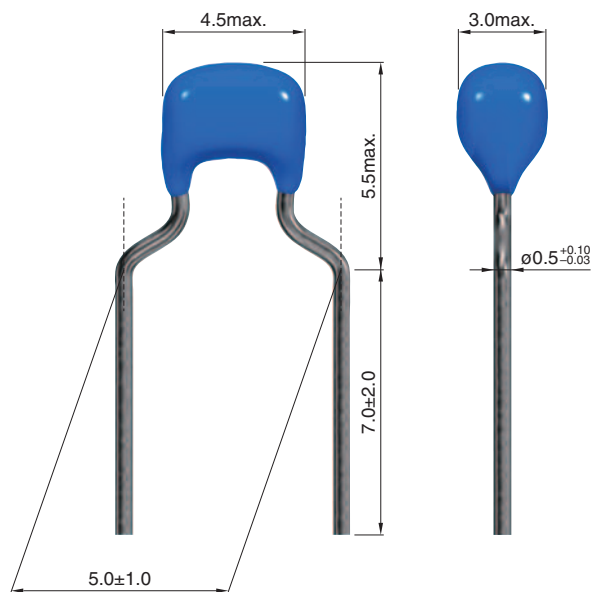

Dimensions in mm

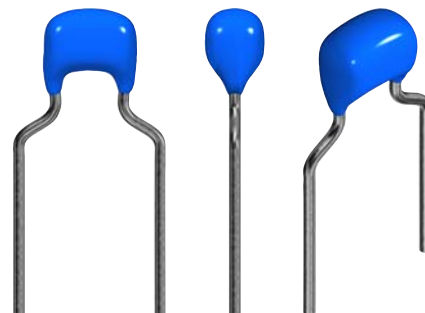

## FA24型

## ■ 电气特性

## □ 特点规格表

种类1 (温度补偿用)

温度特性	电容	容差	额定电压 Edc (V)	型号*
C0G	15nF	±5%	50	FA24C0G1H153JNU0□**
C0G	22nF	±5%	50	FA24C0G1H223JNU0□
C0G	33nF	±5%	50	FA24C0G1H333JNU0□
C0G	3.9nF	±5%	100	FA24C0G2A392JNU0□
C0G	4.7nF	±5%	100	FA24C0G2A472JNU0□
C0G	5.6nF	±5%	100	FA24C0G2A562JNU0□
C0G	6.8nF	±5%	100	FA24C0G2A682JNU0□
C0G	8.2nF	±5%	100	FA24C0G2A822JNU0□
C0G	10nF	±5%	100	FA24C0G2A103JNU0□
C0G	15nF	±5%	100	FA24C0G2A153JRU0□
C0G	22nF	±5%	100	FA24C0G2A223JRU0□
C0G	33nF	±5%	100	FA24C0G2A333JRU0□
C0G	2.7nF	±5%	250	FA24C0G2E272JNU0□
C0G	3.3nF	±5%	250	FA24C0G2E332JNU0□
C0G	3.9nF	±5%	250	FA24C0G2E392JNU0□
C0G	4.7nF	±5%	250	FA24C0G2E472JNU0□
C0G	5.6nF	±5%	250	FA24C0G2E562JNU0□
C0G	6.8nF	±5%	250	FA24C0G2E682JNU0□
C0G	8.2nF	±5%	250	FA24C0G2E822JNU0□
C0G	10nF	±5%	250	FA24C0G2E103JNU0□
C0G	100pF	±5%	450	FA24C0G2W101JNU0□
C0G	120pF	±5%	450	FA24C0G2W121JNU0□
C0G	150pF	±5%	450	FA24C0G2W151JNU0□
C0G	180pF	±5%	450	FA24C0G2W181JNU0□
C0G	220pF	±5%	450	FA24C0G2W221JNU0□
C0G	270pF	±5%	450	FA24C0G2W271JNU0□
C0G	330pF	±5%	450	FA24C0G2W331JNU0□
C0G	390pF	±5%	450	FA24C0G2W391JNU0□
C0G	470pF	±5%	450	FA24C0G2W471JNU0□
C0G	560pF	±5%	450	FA24C0G2W561JNU0□
C0G	680pF	±5%	450	FA24C0G2W681JNU0□
C0G	820pF	±5%	450	FA24C0G2W821JNU0□
C0G	1nF	±5%	450	FA24C0G2W102JNU0□
C0G	1.2nF	±5%	450	FA24C0G2W122JNU0□
C0G	1.5nF	±5%	450	FA24C0G2W152JNU0□
C0G	1.8nF	±5%	450	FA24C0G2W182JNU0□
C0G	2.2nF	±5%	450	FA24C0G2W222JNU0□
C0G	2.7nF	±5%	450	FA24C0G2W272JNU0□
C0G	3.3nF	±5%	450	FA24C0G2W332JNU0□
C0G	3.9nF	±5%	450	FA24C0G2W392JNU0□
C0G	4.7nF	±5%	450	FA24C0G2W472JNU0□
C0G	5.6nF	±5%	450	FA24C0G2W562JNU0□

\* 型号为本公司标准规格品。

\*\* 型号中的□输入包装代码 0 (散装品包装) 或者 6 (编带包装)。

## FA24型

## ■ 电气特性

## □ 特点规格表

种类2 (高介电率类)

温度特性	电容	容差	额定电压 Edc (V)	型号*
X7R	470nF	±10%	25	FA24X7R1E474KNU0□
X7R	3.3uF	±10%	25	FA24X7R1E335KRU0□
X7R	4.7uF	±10%	25	FA24X7R1E475KRU0□
X7R	150nF	±10%	50	FA24X7R1H154KNU0□
X7R	220nF	±10%	50	FA24X7R1H224KNU0□
X7R	330nF	±10%	50	FA24X7R1H334KNU0□
X7R	680nF	±10%	50	FA24X7R1H684KRU0□
X7R	1uF	±10%	50	FA24X7R1H105KRU0□
X7R	1.5uF	±10%	50	FA24X7R1H155KRU0□
X7R	2.2uF	±10%	50	FA24X7R1H225KRU0□
X7R	33nF	±10%	100	FA24X7R2A333KNU0□
X7R	47nF	±10%	100	FA24X7R2A473KNU0□
X7R	68nF	±10%	100	FA24X7R2A683KNU0□
X7R	100nF	±10%	100	FA24X7R2A104KNU0□
X7R	1nF	±10%	250	FA24X7R2E102KNU0□
X7R	1.5nF	±10%	250	FA24X7R2E152KNU0□
X7R	2.2nF	±10%	250	FA24X7R2E222KNU0□
X7R	3.3nF	±10%	250	FA24X7R2E332KNU0□
X7R	4.7nF	±10%	250	FA24X7R2E472KNU0□
X7R	6.8nF	±10%	250	FA24X7R2E682KNU0□
X7R	10nF	±10%	250	FA24X7R2E103KNU0□
X7R	15nF	±10%	250	FA24X7R2E153KNU0□
X7R	22nF	±10%	250	FA24X7R2E223KNU0□
X7S	150nF	±10%	100	FA24X7S2A154KRU0□
X7S	220nF	±10%	100	FA24X7S2A224KRU0□
X7S	330nF	±10%	100	FA24X7S2A334KRU0□
X7S	470nF	±10%	100	FA24X7S2A474KRU0□
X7S	680nF	±10%	100	FA24X7S2A684KRU0□
X7S	1uF	±10%	100	FA24X7S2A105KRU0□
X7T	33nF	±10%	250	FA24X7T2E333KNU0□
X7T	47nF	±10%	250	FA24X7T2E473KNU0□
X7T	68nF	±10%	250	FA24X7T2E683KNU0□
X7T	100nF	±10%	250	FA24X7T2E104KNU0□

\* 型号为本公司标准规格品。

\*\* 型号中的□输入包装代码 0 (散装品包装) 或者 6 (编带包装)。

## FA26型

## ■形状与尺寸

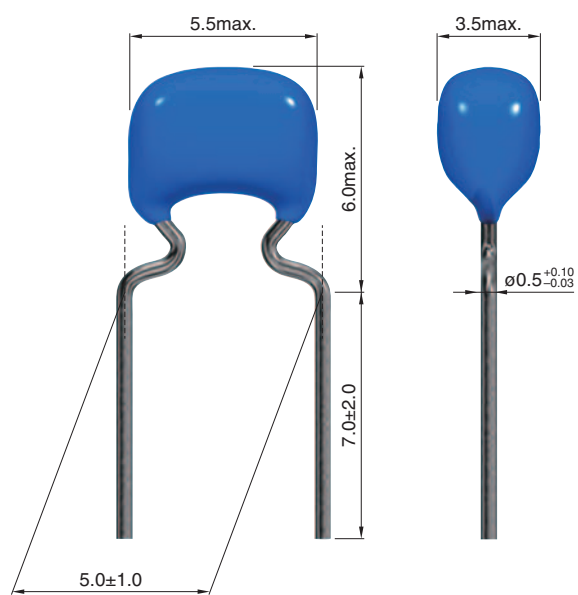

Dimensions in mm

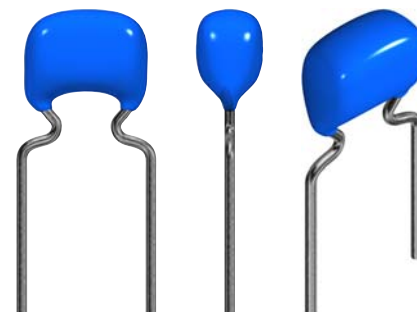

## FA26型

## ■ 电气特性

## □ 特点规格表

种类1 (温度补偿用)

温度特性	电容	容差	额定电压 Edc (V)	型号*
C0G	47nF	±5%	50	FA26C0G1H473JNU0□**
C0G	68nF	±5%	50	FA26C0G1H683JNU0□
C0G	100nF	±5%	50	FA26C0G1H104JNU0□
C0G	15nF	±5%	100	FA26C0G2A153JNU0□
C0G	22nF	±5%	100	FA26C0G2A223JNU0□
C0G	33nF	±5%	100	FA26C0G2A333JNU0□
C0G	47nF	±5%	100	FA26C0G2A473JRU0□
C0G	68nF	±5%	100	FA26C0G2A683JRU0□
C0G	100nF	±5%	100	FA26C0G2A104JRU0□
C0G	15nF	±5%	250	FA26C0G2E153JNU0□
C0G	22nF	±5%	250	FA26C0G2E223JNU0□
C0G	6.8nF	±5%	450	FA26C0G2W682JNU0□
C0G	8.2nF	±5%	450	FA26C0G2W822JNU0□
C0G	10nF	±5%	450	FA26C0G2W103JNU0□
C0G	15nF	±5%	450	FA26C0G2W153JNU0□
C0G	100pF	±5%	630	FA26C0G2J101JNU0□
C0G	120pF	±5%	630	FA26C0G2J121JNU0□
C0G	150pF	±5%	630	FA26C0G2J151JNU0□
C0G	180pF	±5%	630	FA26C0G2J181JNU0□
C0G	220pF	±5%	630	FA26C0G2J221JNU0□
C0G	270pF	±5%	630	FA26C0G2J271JNU0□
C0G	330pF	±5%	630	FA26C0G2J331JNU0□
C0G	390pF	±5%	630	FA26C0G2J391JNU0□
C0G	470pF	±5%	630	FA26C0G2J471JNU0□
C0G	560pF	±5%	630	FA26C0G2J561JNU0□
C0G	680pF	±5%	630	FA26C0G2J681JNU0□
C0G	820pF	±5%	630	FA26C0G2J821JNU0□
C0G	1nF	±5%	630	FA26C0G2J102JNU0□
C0G	1.2nF	±5%	630	FA26C0G2J122JNU0□
C0G	1.5nF	±5%	630	FA26C0G2J152JNU0□
C0G	1.8nF	±5%	630	FA26C0G2J182JNU0□
C0G	2.2nF	±5%	630	FA26C0G2J222JNU0□
C0G	2.7nF	±5%	630	FA26C0G2J272JNU0□
C0G	3.3nF	±5%	630	FA26C0G2J332JNU0□
C0G	3.9nF	±5%	630	FA26C0G2J392JNU0□
C0G	4.7nF	±5%	630	FA26C0G2J472JNU0□
C0G	5.6nF	±5%	630	FA26C0G2J562JNU0□
C0G	6.8nF	±5%	630	FA26C0G2J682JNU0□
C0G	8.2nF	±5%	630	FA26C0G2J822JNU0□
C0G	10nF	±5%	630	FA26C0G2J103JNU0□

\* 型号为本公司标准规格品。

\*\* 型号中的□输入包装代码 0 (散装品包装) 或者 6 (编带包装)。

## FA26型

## ■ 电气特性

## □ 特点规格表

种类2 (高介电率类)

温度特性	电容	容差	额定电压 Edc (V)	型号*
X7R	1uF	±10%	25	FA26X7R1E105KNU0□**
X7R	1.5uF	±10%	25	FA26X7R1E155KNU0□
X7R	2.2uF	±10%	25	FA26X7R1E225KNU0□
X7R	6.8uF	±10%	25	FA26X7R1E685KRU0□
X7R	10uF	±10%	25	FA26X7R1E106KRU0□
X7R	470nF	±10%	50	FA26X7R1H474KNU0□
X7R	680nF	±10%	50	FA26X7R1H684KNU0□
X7R	3.3uF	±10%	50	FA26X7R1H335KRU0□
X7R	4.7uF	±10%	50	FA26X7R1H475KRU0□
X7R	150nF	±10%	100	FA26X7R2A154KNU0□
X7R	220nF	±10%	100	FA26X7R2A224KNU0□
X7R	330nF	±10%	100	FA26X7R2A334KNU0□
X7R	470nF	±10%	100	FA26X7R2A474KNU0□
X7R	680nF	±10%	100	FA26X7R2A684KNU0□
X7R	1uF	±10%	100	FA26X7R2A105KNU0□
X7R	33nF	±10%	250	FA26X7R2E333KNU0□
X7R	47nF	±10%	250	FA26X7R2E473KNU0□
X7R	68nF	±10%	250	FA26X7R2E683KNU0□
X7R	100nF	±10%	250	FA26X7R2E104KNU0□
X7R	1nF	±10%	630	FA26X7R2J102KNU0□
X7R	1.5nF	±10%	630	FA26X7R2J152KNU0□
X7R	2.2nF	±10%	630	FA26X7R2J222KNU0□
X7R	3.3nF	±10%	630	FA26X7R2J332KNU0□
X7R	4.7nF	±10%	630	FA26X7R2J472KNU0□
X7R	6.8nF	±10%	630	FA26X7R2J682KNU0□
X7R	10nF	±10%	630	FA26X7R2J103KNU0□
X7R	15nF	±10%	630	FA26X7R2J153KNU0□
X7R	22nF	±10%	630	FA26X7R2J223KNU0□
X7R	33nF	±10%	630	FA26X7R2J333KNU0□
X7S	1.5uF	±10%	100	FA26X7S2A155KRU0□
X7S	2.2uF	±10%	100	FA26X7S2A225KRU0□
X7S	3.3uF	±10%	100	FA26X7S2A335KRU0□
X7T	150nF	±10%	250	FA26X7T2E154KNU0□
X7T	220nF	±10%	250	FA26X7T2E224KNU0□

\* 型号为本公司标准规格品。

\*\* 型号中的□输入包装代码 0 (散装品包装) 或者 6 (编带包装)。

## FA20型

## ■形状与尺寸

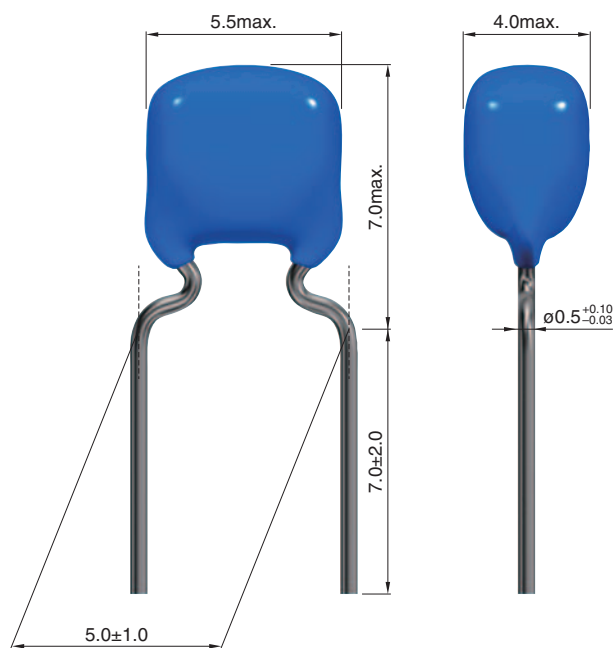

Dimensions in mm

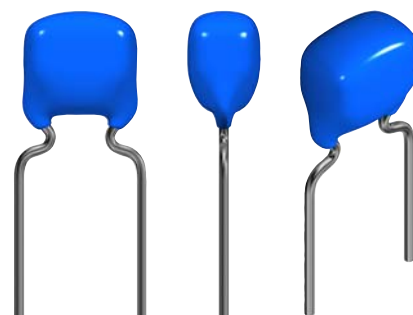

## FA20型

## ■ 电气特性

## □ 特点规格表

种类1 (温度补偿用)

温度特性	电容	容差	额定电压 Edc (V)	型号*
C0G	47nF	±5%	100	FA20C0G2A473JNU0□**
C0G	68nF	±5%	100	FA20C0G2A683JNU0□
C0G	33nF	±5%	250	FA20C0G2E333JNU0□
C0G	47nF	±5%	250	FA20C0G2E473JNU0□
C0G	22nF	±5%	450	FA20C0G2W223JNU0□
C0G	33nF	±5%	450	FA20C0G2W333JNU0□
C0G	15nF	±5%	630	FA20C0G2J153JNU0□
C0G	22nF	±5%	630	FA20C0G2J223JNU0□
C0G	33nF	±5%	630	FA20C0G2J333JNU0□

\* 型号为本公司标准规格品。

\*\* 型号中的□输入包装代码 0 (散装品包装) 或者 6 (编带包装)。

种类2 (高介电率类)

温度特性	电容	容差	额定电压 Edc (V)	型号*
X7R	3.3uF	±10%	25	FA20X7R1E335KNU0□**
X7R	4.7uF	±10%	25	FA20X7R1E475KNU0□
X7R	1uF	±10%	50	FA20X7R1H105KNU0□
X7R	1.5uF	±10%	50	FA20X7R1H155KNU0□
X7R	1.5uF	±10%	100	FA20X7R2A155KRU0□
X7R	2.2uF	±10%	100	FA20X7R2A225KRU0□
X7R	150nF	±10%	250	FA20X7R2E154KNU0□
X7R	220nF	±10%	250	FA20X7R2E224KNU0□
X7R	47nF	±10%	630	FA20X7R2J473KNU0□
X7R	68nF	±10%	630	FA20X7R2J683KNU0□
X7S	6.8uF	±10%	50	FA20X7S1H685KRU0□
X7S	10uF	±10%	50	FA20X7S1H106KRU0□
X7S	4.7uF	±10%	100	FA20X7S2A475KRU0□
X7T	330nF	±10%	250	FA20X7T2E334KNU0□

\* 型号为本公司标准规格品。

\*\* 型号中的□输入包装代码 0 (散装品包装) 或者 6 (编带包装)。



## FA22型

## ■形状与尺寸

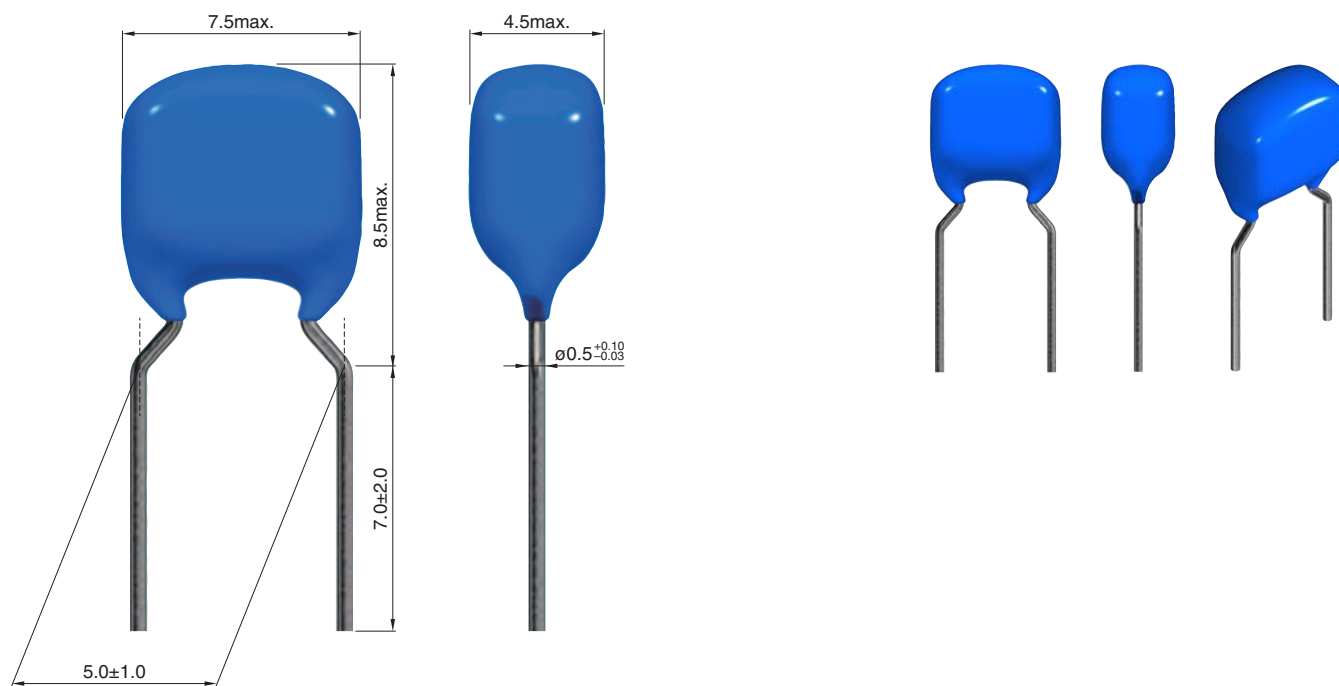

Dimensions in mm

## FA22型

## ■ 电气特性

## □ 特点规格表

种类1 (温度补偿用)

温度特性	电容	容差	额定电压 Edc (V)	型号*
C0G	150nF	±5%	50	FA22C0G1H154JNU0□**
C0G	220nF	±5%	50	FA22C0G1H224JNU0□
C0G	100nF	±5%	100	FA22C0G2A104JNU0□
C0G	68nF	±5%	250	FA22C0G2E683JRU0□
C0G	100nF	±5%	250	FA22C0G2E104JRU0□
C0G	47nF	±5%	450	FA22C0G2W473JNU0□
C0G	68nF	±5%	450	FA22C0G2W683JNU0□
C0G	47nF	±5%	630	FA22C0G2J473JNU0□

\* 型号为本公司标准规格品。

\*\* 型号中的□输入包装代码 0 (散装品包装) 或者 6 (编带包装)。

种类2 (高介电率类)

温度特性	电容	容差	额定电压 Edc (V)	型号*
X7R	10uF	±10%	25	FA22X7R1E106KNU0□**
X7R	15uF	±20%	25	FA22X7R1E156MRU0□
X7R	22uF	±20%	25	FA22X7R1E226MRU0□
X7R	2.2uF	±10%	50	FA22X7R1H225KNU0□
X7R	3.3uF	±10%	50	FA22X7R1H335KNU0□
X7R	4.7uF	±10%	50	FA22X7R1H475KRU0□
X7R	6.8uF	±10%	50	FA22X7R1H685KRU0□
X7R	1.5uF	±10%	100	FA22X7R2A155KNU0□
X7R	2.2uF	±10%	100	FA22X7R2A225KNU0□
X7R	330nF	±10%	250	FA22X7R2E334KNU0□
X7R	470nF	±10%	250	FA22X7R2E474KNU0□
X7R	100nF	±10%	630	FA22X7R2J104KNU0□
X7T	680nF	±10%	250	FA22X7T2E684KNU0□
X7T	1uF	±10%	250	FA22X7T2E105KNU0□

\* 型号为本公司标准规格品。

\*\* 型号中的□输入包装代码 0 (散装品包装) 或者 6 (编带包装)。

## FA23型

## ■形状与尺寸

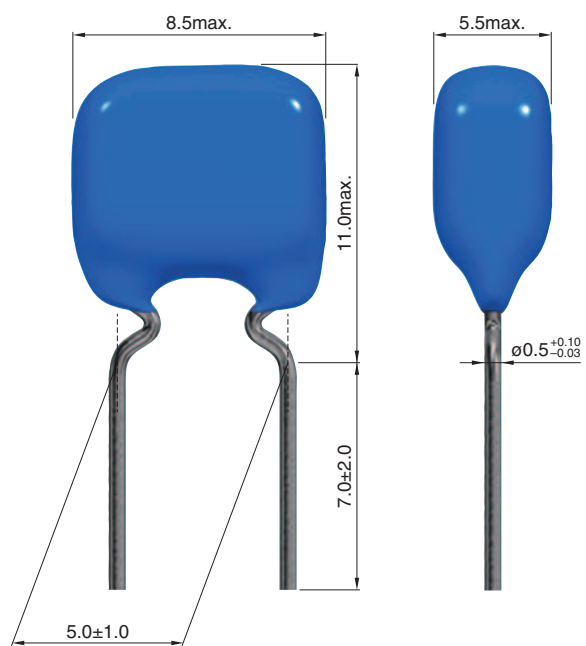

Dimensions in mm

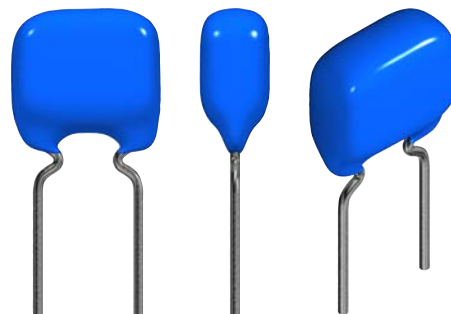

## FA23型

## ■ 电气特性

## □ 特点规格表

种类1 (温度补偿用)

温度特性	电容	容差	额定电压 Edc (V)	型号*
C0G	150nF	±5%	100	FA23C0G2A154JNU0□**
C0G	150nF	±5%	250	FA23C0G2E154JRU0□
C0G	100nF	±5%	450	FA23C0G2W104JNU0□
C0G	68nF	±5%	630	FA23C0G2J683JRU0□
C0G	100nF	±5%	630	FA23C0G2J104JRU0□

\* 型号为本公司标准规格品。

\*\* 型号中的□输入包装代码 0 (散装品包装) 或者 6 (编带包装)。

种类2 (高介电率类)

温度特性	电容	容差	额定电压 Edc (V)	型号*
X7R	22μF	±20%	25	FA23X7R1E226MNU0□**
X7R	10μF	±10%	50	FA23X7R1H106KRU0□
X7R	3.3μF	±10%	100	FA23X7R2A335KNU0□
X7R	4.7μF	±10%	100	FA23X7R2A475KNU0□
X7R	680nF	±10%	250	FA23X7R2E684KNU0□
X7R	1μF	±10%	250	FA23X7R2E105KNU0□
X7R	150nF	±10%	630	FA23X7R2J154KNU0□
X7R	220nF	±10%	630	FA23X7R2J224KNU0□
X7S	6.8μF	±10%	100	FA23X7S2A685KRU0□
X7S	10μF	±10%	100	FA23X7S2A106KRU0□
X7S	15μF	±20%	100	FA23X7S2A156MRU0□
X7T	1.5μF	±10%	250	FA23X7T2E155KNU0□
X7T	2.2μF	±10%	250	FA23X7T2E225KNU0□

\* 型号为本公司标准规格品。

\*\* 型号中的□输入包装代码 0 (散装品包装) 或者 6 (编带包装)。

## FA18型

## ■形状与尺寸

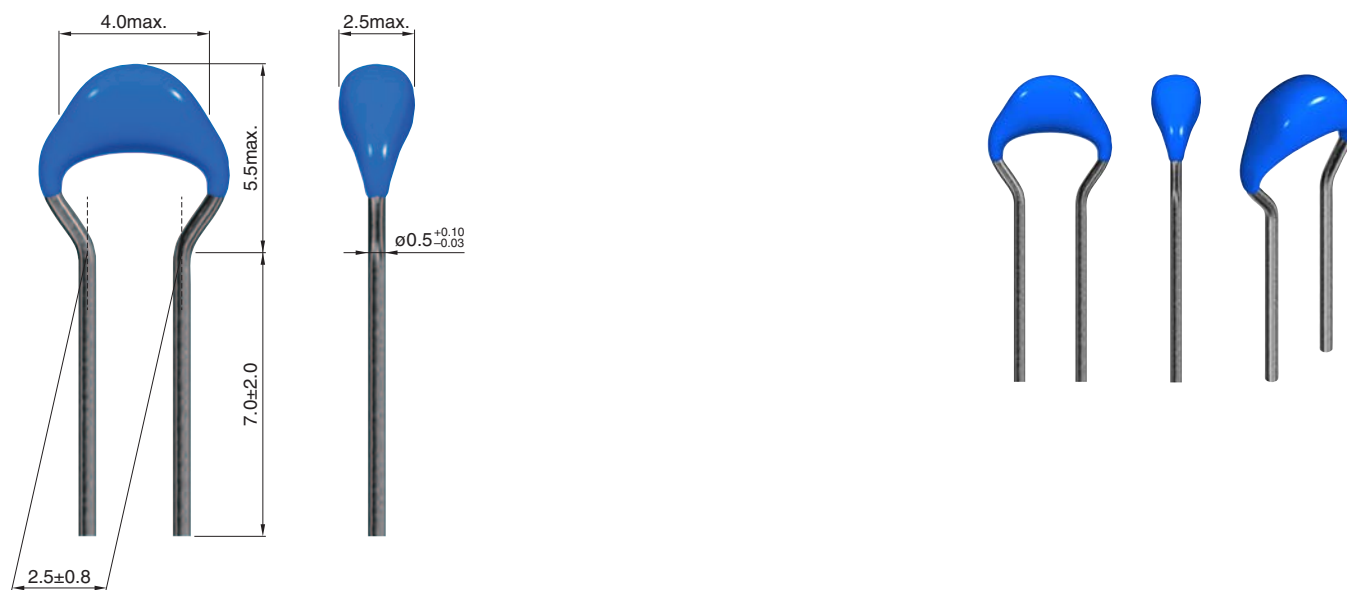

Dimensions in mm

## FA18型

## ■ 电气特性

## □ 特点规格表

种类1 (温度补偿用)

温度特性	电容	容差	额定电压 Edc (V)	型号*
C0G	1.0pF	±0.25pF	50	FA18C0G1H010CNU0□**
C0G	1.5pF	±0.25pF	50	FA18C0G1H1R5CNU0□
C0G	2.2pF	±0.25pF	50	FA18C0G1H2R2CNU0□
C0G	3.3pF	±0.25pF	50	FA18C0G1H3R3CNU0□
C0G	4.7pF	±0.25pF	50	FA18C0G1H4R7CNU0□
C0G	6.8pF	±0.5pF	50	FA18C0G1H6R8DNU0□
C0G	10pF	±0.5pF	50	FA18C0G1H100DNU0□
C0G	15pF	±5%	50	FA18C0G1H150JNU0□
C0G	22pF	±5%	50	FA18C0G1H220JNU0□
C0G	33pF	±5%	50	FA18C0G1H330JNU0□
C0G	47pF	±5%	50	FA18C0G1H470JNU0□
C0G	68pF	±5%	50	FA18C0G1H680JNU0□
C0G	100pF	±5%	50	FA18C0G1H101JNU0□
C0G	120pF	±5%	50	FA18C0G1H121JNU0□
C0G	150pF	±5%	50	FA18C0G1H151JNU0□
C0G	180pF	±5%	50	FA18C0G1H181JNU0□
C0G	220pF	±5%	50	FA18C0G1H221JNU0□
C0G	270pF	±5%	50	FA18C0G1H271JNU0□
C0G	330pF	±5%	50	FA18C0G1H331JNU0□
C0G	390pF	±5%	50	FA18C0G1H391JNU0□
C0G	470pF	±5%	50	FA18C0G1H471JNU0□
C0G	560pF	±5%	50	FA18C0G1H561JNU0□
C0G	680pF	±5%	50	FA18C0G1H681JNU0□
C0G	820pF	±5%	50	FA18C0G1H821JNU0□
C0G	1nF	±5%	50	FA18C0G1H102JNU0□
C0G	1.2nF	±5%	50	FA18C0G1H122JNU0□
C0G	1.5nF	±5%	50	FA18C0G1H152JNU0□
C0G	1.8nF	±5%	50	FA18C0G1H182JNU0□
C0G	2.2nF	±5%	50	FA18C0G1H222JNU0□
C0G	2.7nF	±5%	50	FA18C0G1H272JNU0□
C0G	3.3nF	±5%	50	FA18C0G1H332JNU0□
C0G	3.9nF	±5%	50	FA18C0G1H392JNU0□
C0G	4.7nF	±5%	50	FA18C0G1H472JNU0□
C0G	5.6nF	±5%	50	FA18C0G1H562JNU0□
C0G	6.8nF	±5%	50	FA18C0G1H682JNU0□
C0G	8.2nF	±5%	50	FA18C0G1H822JNU0□
C0G	10nF	±5%	50	FA18C0G1H103JNU0□
C0G	1.0pF	±0.25pF	100	FA18C0G2A010CNU0□
C0G	1.5pF	±0.25pF	100	FA18C0G2A1R5CNU0□
C0G	2.2pF	±0.25pF	100	FA18C0G2A2R2CNU0□
C0G	3.3pF	±0.25pF	100	FA18C0G2A3R3CNU0□
C0G	4.7pF	±0.25pF	100	FA18C0G2A4R7CNU0□
C0G	6.8pF	±0.5pF	100	FA18C0G2A6R8DNU0□
C0G	10pF	±0.5pF	100	FA18C0G2A100DNU0□
C0G	15pF	±5%	100	FA18C0G2A150JNU0□
C0G	22pF	±5%	100	FA18C0G2A220JNU0□
C0G	33pF	±5%	100	FA18C0G2A330JNU0□
C0G	47pF	±5%	100	FA18C0G2A470JNU0□
C0G	68pF	±5%	100	FA18C0G2A680JNU0□
C0G	100pF	±5%	100	FA18C0G2A101JNU0□

\* 型号为本公司标准规格品。

\*\* 型号中的□输入包装代码 0 (散装品包装) 或者 6 (编带包装)。

## FA18型

## ■ 电气特性

## □ 特点规格表

种类1 (温度补偿用)

温度特性	电容	容差	额定电压 Edc (V)	型号*
C0G	120pF	±5%	100	FA18C0G2A121JNU0□**
C0G	150pF	±5%	100	FA18C0G2A151JNU0□
C0G	180pF	±5%	100	FA18C0G2A181JNU0□
C0G	220pF	±5%	100	FA18C0G2A221JNU0□
C0G	270pF	±5%	100	FA18C0G2A271JNU0□
C0G	330pF	±5%	100	FA18C0G2A331JNU0□
C0G	390pF	±5%	100	FA18C0G2A391JNU0□
C0G	470pF	±5%	100	FA18C0G2A471JNU0□
C0G	560pF	±5%	100	FA18C0G2A561JNU0□
C0G	680pF	±5%	100	FA18C0G2A681JNU0□
C0G	820pF	±5%	100	FA18C0G2A821JNU0□
C0G	1nF	±5%	100	FA18C0G2A102JNU0□
C0G	1.2nF	±5%	100	FA18C0G2A122JNU0□
C0G	1.5nF	±5%	100	FA18C0G2A152JNU0□
C0G	1.8nF	±5%	100	FA18C0G2A182JNU0□
C0G	2.2nF	±5%	100	FA18C0G2A222JNU0□
C0G	2.7nF	±5%	100	FA18C0G2A272JNU0□
C0G	3.3nF	±5%	100	FA18C0G2A332JNU0□
C0G	3.9nF	±5%	100	FA18C0G2A392JRU0□
C0G	4.7nF	±5%	100	FA18C0G2A472JRU0□
C0G	5.6nF	±5%	100	FA18C0G2A562JRU0□
C0G	6.8nF	±5%	100	FA18C0G2A682JRU0□
C0G	8.2nF	±5%	100	FA18C0G2A822JRU0□
C0G	10nF	±5%	100	FA18C0G2A103JRU0□

\* 型号为本公司标准规格品。

\*\* 型号中的□输入包装代码 0 (散装品包装) 或者 6 (编带包装)。

## FA18型

## ■ 电气特性

## □ 特点规格表

种类2 (高介电率类)

温度特性	电容	容差	额定电压 Edc (V)	型号*
X7R	150nF	±10%	25	FA18X7R1E154KNU0□**
X7R	680nF	±10%	25	FA18X7R1E684KRU0□
X7R	1μF	±10%	25	FA18X7R1E105KRU0□
X7R	1nF	±10%	50	FA18X7R1H102KNU0□
X7R	1.5nF	±10%	50	FA18X7R1H152KNU0□
X7R	2.2nF	±10%	50	FA18X7R1H222KNU0□
X7R	3.3nF	±10%	50	FA18X7R1H332KNU0□
X7R	4.7nF	±10%	50	FA18X7R1H472KNU0□
X7R	6.8nF	±10%	50	FA18X7R1H682KNU0□
X7R	10nF	±10%	50	FA18X7R1H103KNU0□
X7R	15nF	±10%	50	FA18X7R1H153KNU0□
X7R	22nF	±10%	50	FA18X7R1H223KNU0□
X7R	33nF	±10%	50	FA18X7R1H333KNU0□
X7R	47nF	±10%	50	FA18X7R1H473KNU0□
X7R	68nF	±10%	50	FA18X7R1H683KNU0□
X7R	100nF	±10%	50	FA18X7R1H104KNU0□
X7R	150nF	±10%	50	FA18X7R1H154KRU0□
X7R	220nF	±10%	50	FA18X7R1H224KRU0□
X7R	330nF	±10%	50	FA18X7R1H334KRU0□
X7R	470nF	±10%	50	FA18X7R1H474KRU0□
X7R	1nF	±10%	100	FA18X7R2A102KNU0□
X7R	1.5nF	±10%	100	FA18X7R2A152KNU0□
X7R	2.2nF	±10%	100	FA18X7R2A222KNU0□
X7R	3.3nF	±10%	100	FA18X7R2A332KNU0□
X7R	4.7nF	±10%	100	FA18X7R2A472KNU0□
X7R	6.8nF	±10%	100	FA18X7R2A682KNU0□
X7R	10nF	±10%	100	FA18X7R2A103KNU0□
X7R	15nF	±10%	100	FA18X7R2A153KNU0□
X7R	22nF	±10%	100	FA18X7R2A223KNU0□
X7S	33nF	±10%	100	FA18X7S2A333KRU0□
X7S	47nF	±10%	100	FA18X7S2A473KRU0□
X7S	68nF	±10%	100	FA18X7S2A683KRU0□
X7S	100nF	±10%	100	FA18X7S2A104KRU0□

\* 型号为本公司标准规格品。

\*\* 型号中的□输入包装代码 0 (散装品包装) 或者 6 (编带包装)。



## FA14型

## ■形状与尺寸

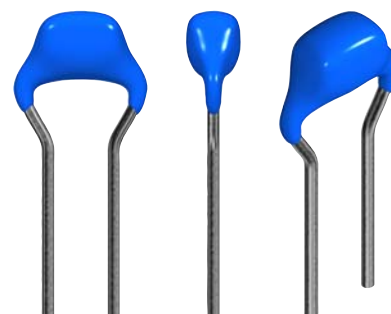
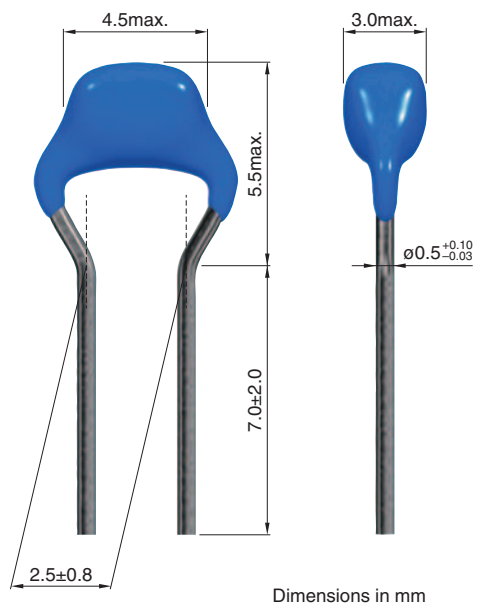

## FA14型

## ■ 电气特性

## □ 特点规格表

种类1 (温度补偿用)

温度特性	电容	容差	额定电压 Edc (V)	型号*
C0G	15nF	±5%	50	FA14C0G1H153JNU0□
C0G	22nF	±5%	50	FA14C0G1H223JNU0□
C0G	33nF	±5%	50	FA14C0G1H333JNU0□
C0G	3.9nF	±5%	100	FA14C0G2A392JNU0□
C0G	4.7nF	±5%	100	FA14C0G2A472JNU0□
C0G	5.6nF	±5%	100	FA14C0G2A562JNU0□
C0G	6.8nF	±5%	100	FA14C0G2A682JNU0□
C0G	8.2nF	±5%	100	FA14C0G2A822JNU0□
C0G	10nF	±5%	100	FA14C0G2A103JNU0□
C0G	15nF	±5%	100	FA14C0G2A153JRU0□
C0G	22nF	±5%	100	FA14C0G2A223JRU0□
C0G	33nF	±5%	100	FA14C0G2A333JRU0□

\* 型号为本公司标准规格品。

\*\* 型号中的□输入包装代码 0 (散装品包装) 或者 6 (编带包装)。

## □ 特点规格表

种类2 (高介电率类)

温度特性	电容	容差	额定电压 Edc (V)	型号*
X7R	470nF	±10%	25	FA14X7R1E474KNU0□**
X7R	3.3uF	±10%	25	FA14X7R1E335KRU0□
X7R	4.7uF	±10%	25	FA14X7R1E475KRU0□
X7R	150nF	±10%	50	FA14X7R1H154KNU0□
X7R	220nF	±10%	50	FA14X7R1H224KNU0□
X7R	330nF	±10%	50	FA14X7R1H334KNU0□
X7R	680nF	±10%	50	FA14X7R1H684KRU0□
X7R	1uF	±10%	50	FA14X7R1H105KRU0□
X7R	1.5uF	±10%	50	FA14X7R1H155KRU0□
X7R	2.2uF	±10%	50	FA14X7R1H225KRU0□
X7R	33nF	±10%	100	FA14X7R2A333KNU0□
X7R	47nF	±10%	100	FA14X7R2A473KNU0□
X7R	68nF	±10%	100	FA14X7R2A683KNU0□
X7R	100nF	±10%	100	FA14X7R2A104KNU0□
X7S	150nF	±10%	100	FA14X7S2A154KRU0□
X7S	220nF	±10%	100	FA14X7S2A224KRU0□
X7S	330nF	±10%	100	FA14X7S2A334KRU0□
X7S	470nF	±10%	100	FA14X7S2A474KRU0□
X7S	680nF	±10%	100	FA14X7S2A684KRU0□
X7S	1uF	±10%	100	FA14X7S2A105KRU0□

\* 型号为本公司标准规格品。

\*\* 型号中的□输入包装代码 0 (散装品包装) 或者 6 (编带包装)。

## FA16型

## ■形状与尺寸

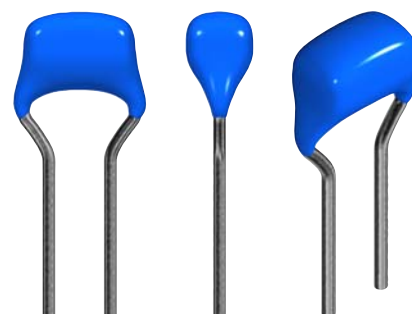

## FA16型

## ■ 电气特性

## □ 特点规格表

种类1 (温度补偿用)

温度特性	电容	容差	额定电压 Edc (V)	型号*
C0G	47nF	±5%	50	FA16C0G1H473JNU0□**
C0G	68nF	±5%	50	FA16C0G1H683JNU0□
C0G	100nF	±5%	50	FA16C0G1H104JNU0□
C0G	15nF	±5%	100	FA16C0G2A153JNU0□
C0G	22nF	±5%	100	FA16C0G2A223JNU0□
C0G	33nF	±5%	100	FA16C0G2A333JNU0□
C0G	47nF	±5%	100	FA16C0G2A473JRU0□
C0G	68nF	±5%	100	FA16C0G2A683JRU0□
C0G	100nF	±5%	100	FA16C0G2A104JRU0□

\* 型号为本公司标准规格品。

\*\* 型号中的□输入包装代码 0 (散装品包装) 或者 6 (编带包装)。

## □ 特点规格表

种类2 (高介电率类)

温度特性	电容	容差	额定电压 Edc (V)	型号*
X7R	1uF	±10%	25	FA16X7R1E105KNU0□**
X7R	1.5uF	±10%	25	FA16X7R1E155KNU0□
X7R	2.2uF	±10%	25	FA16X7R1E225KNU0□
X7R	6.8uF	±10%	25	FA16X7R1E685KRU0□
X7R	10uF	±10%	25	FA16X7R1E106KRU0□
X7R	470nF	±10%	50	FA16X7R1H474KNU0□
X7R	680nF	±10%	50	FA16X7R1H684KNU0□
X7R	3.3uF	±10%	50	FA16X7R1H335KRU0□
X7R	4.7uF	±10%	50	FA16X7R1H475KRU0□
X7R	150nF	±10%	100	FA16X7R2A154KNU0□
X7R	220nF	±10%	100	FA16X7R2A224KNU0□
X7R	330nF	±10%	100	FA16X7R2A334KNU0□
X7R	470nF	±10%	100	FA16X7R2A474KNU0□
X7R	680nF	±10%	100	FA16X7R2A684KNU0□
X7R	1uF	±10%	100	FA16X7R2A105KNU0□
X7S	1.5uF	±10%	100	FA16X7S2A155KRU0□
X7S	2.2uF	±10%	100	FA16X7S2A225KRU0□
X7S	3.3uF	±10%	100	FA16X7S2A335KRU0□

\* 型号为本公司标准规格品。

\*\* 型号中的□输入包装代码 0 (散装品包装) 或者 6 (编带包装)。

## FA11型

## ■形状与尺寸

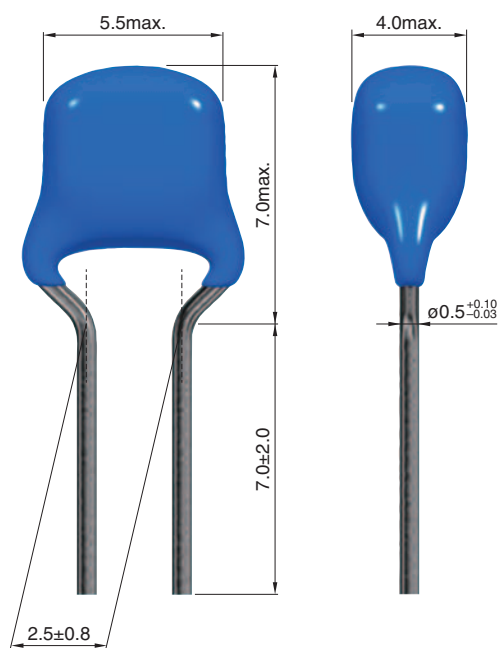

Dimensions in mm

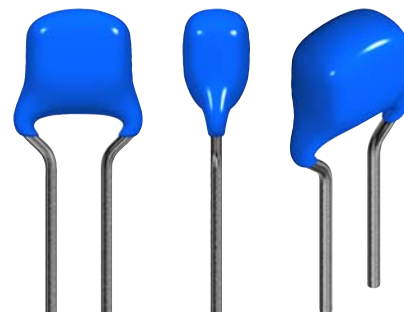

## FA11型

## ■ 电气特性

## □ 特点规格表

种类1 (温度补偿用)

温度特性	电容	容差	额定电压 Edc (V)	型号*
C0G	47nF	±5%	100	FA11C0G2A473JNU0□**
C0G	68nF	±5%	100	FA11C0G2A683JNU0□

\* 型号为本公司标准规格品。

\*\* 型号中的□输入包装代码 0 (散装品包装) 或者 6 (编带包装)。

种类2 (高介电率类)

温度特性	电容	容差	额定电压 Edc (V)	型号*
X7R	3.3uF	±10%	25	FA11X7R1E335KNU0□**
X7R	4.7uF	±10%	25	FA11X7R1E475KNU0□
X7R	1uF	±10%	50	FA11X7R1H105KNU0□
X7R	1.5uF	±10%	50	FA11X7R1H155KNU0□
X7R	1.5uF	±10%	100	FA11X7R2A155KRU0□
X7R	2.2uF	±10%	100	FA11X7R2A225KRU0□
X7S	6.8uF	±10%	50	FA11X7S1H685KRU0□
X7S	10uF	±10%	50	FA11X7S1H106KRU0□
X7S	4.7uF	±10%	100	FA11X7S2A475KRU0□

\* 型号为本公司标准规格品。

\*\* 型号中的□输入包装代码 0 (散装品包装) 或者 6 (编带包装)。

## 包装形式

### ■ 编带尺寸

□ 引线间距 5.0 mm

(FA28, FA24, FA26, FA20, FA22, FA23 型)

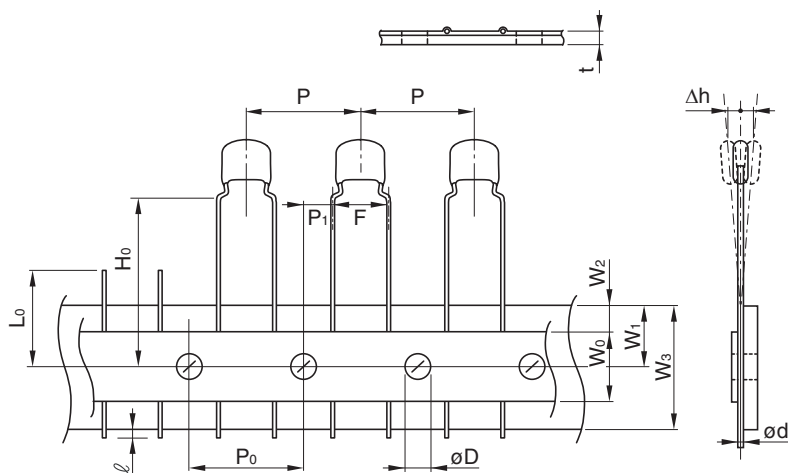

记号	尺寸(mm)
P	(12.7)
P <sub>0</sub> *1	(12.7)
P <sub>1</sub>	(3.85)
W <sub>0</sub>	12.0±1.0
W <sub>1</sub>	9.0±0.5
W <sub>2</sub> *2	3.0max.
W <sub>3</sub>	18.0+1.0, -0.5
H <sub>0</sub>	16.0±0.8
l	1.0max.
t	0.6±0.2
L <sub>0</sub> *3	11.0max.
F	5.0+0.8, -0.2
ød	ø0.5+0.1, -0.03
øD	(ø4.0)
Δh	(±2)

括号"()"中的值是参考值。

\*1 20个间距时的累积间距偏差为±2mm。

\*2 粘贴胶带不得超出台纸。

\*3 连续未穿孔的产品不超过3个。

□ 引线间距 2.5 mm

(FA18, FA14, FA16, FA11 型)

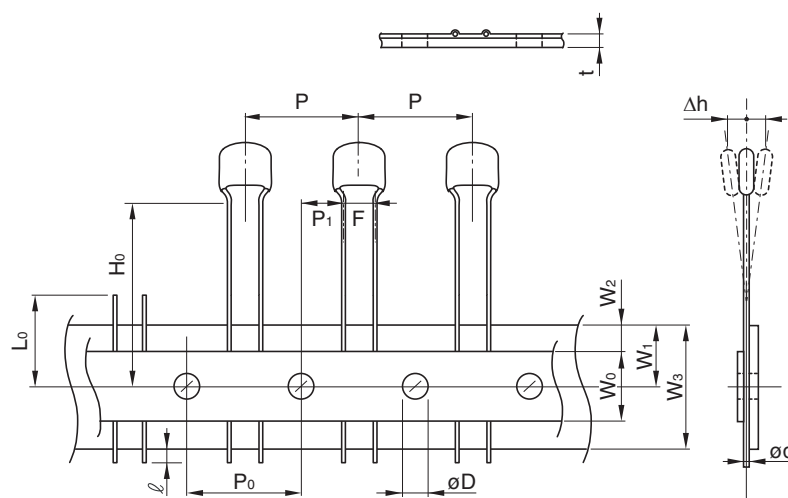

记号	尺寸(mm)
P	(12.7)
P <sub>0</sub> *1	(12.7)
P <sub>1</sub>	(5.1)
W <sub>0</sub>	12.0±1.0
W <sub>1</sub>	9.0±0.5
W <sub>2</sub> *2	3.0max.
W <sub>3</sub>	18.0+1.0, -0.5
H <sub>0</sub>	16.0±0.8
l	1.0max.
t	0.6±0.2
L <sub>0</sub> *3	11.0max.
F	2.5+0.5, -0.2
ød	ø0.5+0.1, -0.03
øD	(ø4.0)
Δh	(±2)

括号"()"中的值是参考值。

\*1 20个间距时的累积间距偏差为±2mm。

\*2 粘贴胶带不得超出台纸。

\*3 连续未穿孔的产品不超过3个。

### ■ 折叠用 内装箱尺寸

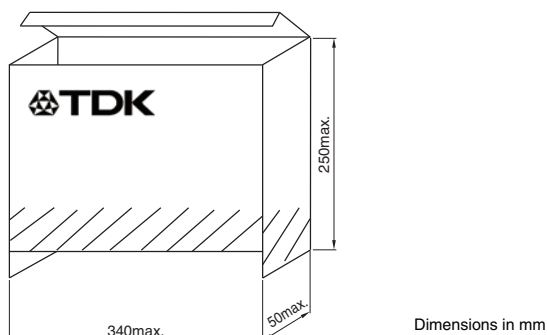

⚠ 为了能够更加正确、安全地使用产品，请务必索取能进一步确认详细特性、规格的采购规格书。  
记载内容可能因为产品改良等原因不经预告而更改，恕不另行通知。