

Common Mode Choke AWCU Series

**Automotive
AEC-Q200**

RoHS Compliant
Halogen Free
REACH Compliant



- Noise
Suppression
- Unshield
- Wire
Wound
- Ferrite
- General
Signal line

Part Numbering

A	WCU	00	201212	300	M	02
Grade	Series Name	Control Code	Dimensions Code (mm)	Impedance (Ω)	Tolerance	Internal Code
			2.05x1.25x1.2	300 30	M ±20%	02 USB2.0
			3.2x1.6x1.9	121 120	Y ±25%	03 USB3.0

A	WCU	00	453226	510	X	G0
Grade	Series Name	Control Code	Dimensions Code (mm)	Inductance (uH)	Tolerance	Internal Code
			3.3x2.5x2.3	110 11	T ±30%	G0
			3.3x2.5x2.5	510 51	X -	TE
			4.5x3.2x2.6	101 100		T2
			4.5x3.2x2.8			MF

Common Mode Choke AWCU Series

**Automotive
AEC-Q200**

AWCU00201212-02 Type

■ Dimensions / Recommended Land Pattern

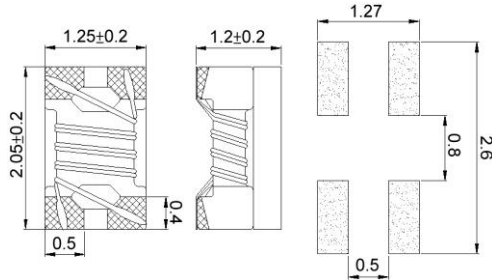

■ NO Polarity Equivalent circuit

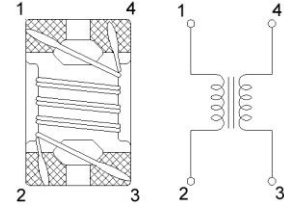

unit:mm

■ Electrical Characteristics

Part No.	Impedance (Ω)	Test Freq. (MHz)	RDC (Ω)Max.	IDC (mA)	Rated Voltage (Vdc)Max.	Withstanding Voltage (Vdc)	Insulation Resistance (MΩ)Min.	Tolerance (±%)
AWCU00201212300□02	30	100	0.2	450	50	125	10	20
AWCU00201212670□02	67	100	0.25	400	50	125	10	20
AWCU00201212750□02	75	100	0.3	360	50	125	10	20
AWCU00201212900□02	90	100	0.35	330	50	125	10	20
AWCU00201212121□02	120	100	0.3	400	50	125	10	20
AWCU00201212161□02	160	100	0.35	350	50	125	10	20
AWCU00201212181□02	180	100	0.35	330	50	125	10	20
AWCU00201212201□02	200	100	0.35	330	50	125	10	20
AWCU00201212221□02	220	100	0.35	310	50	125	10	20
AWCU00201212261□02	260	100	0.4	300	50	125	10	20
AWCU00201212301□02	300	100	0.4	290	50	125	10	20
AWCU00201212361□02	360	100	0.45	280	50	125	10	20
AWCU00201212371□02	370	100	0.45	280	50	125	10	20
AWCU00201212501□02	500	100	0.55	170	50	125	10	20
AWCU00201212671□02	670	100	0.6	140	50	125	10	20
AWCU00201212901□02	900	100	0.6	80	50	125	10	20

Note: When ordering, please specify tolerance code. Tolerance: M=±20%

1. Operating temperature range - 50°C ~ 150°C(Including self - temperature rise)
2. RDC: SINGLE WIRE TEST VALUE
3. IDC for Inductance drop 10% from its value without current.
4. Measure Equipment:

Z: Agilent HP4287A+Agilent 16197A

RDC: Chroma 16502 (Single Wire Test Value)

IDC: HP4284A+HP42841A/HP4285A+HP42841A

Common Mode Choke AWCU Series

Automotive
AEC-Q200

AWCU00201212-02 Type

■ Characteristics Graph

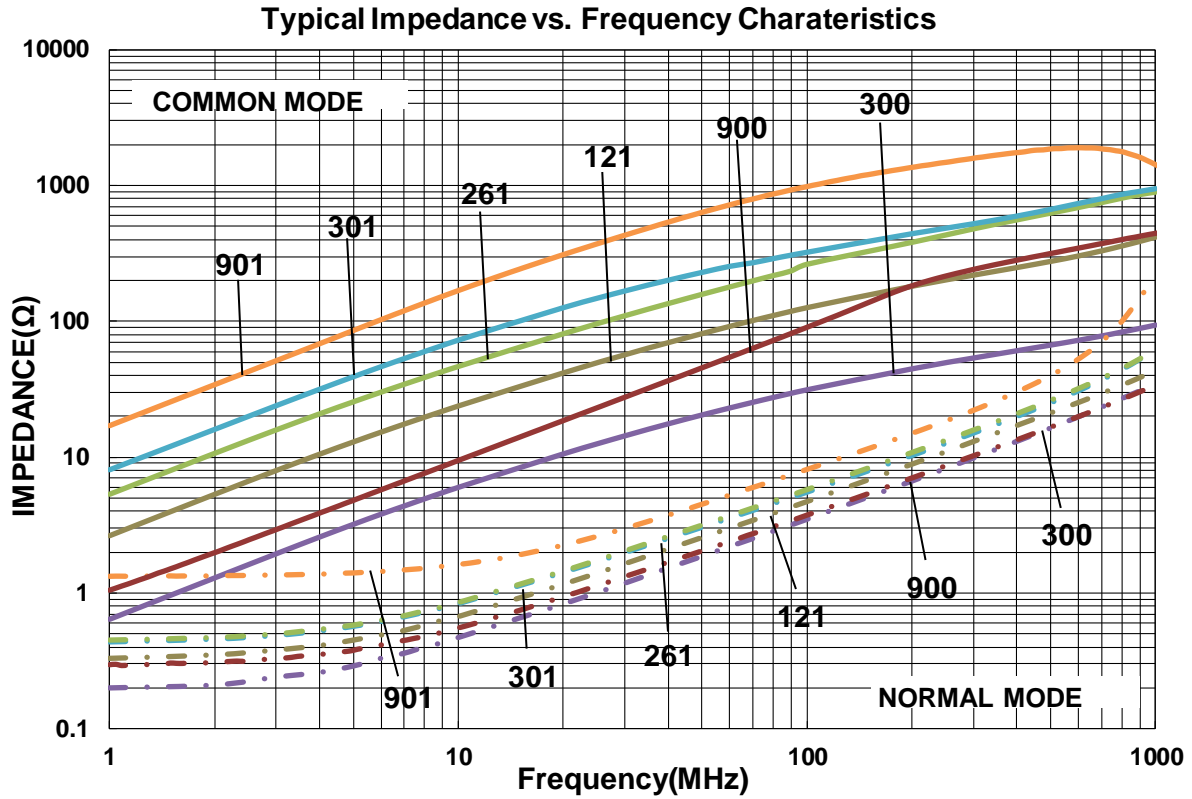

Common Mode Choke AWCU Series

**Automotive
AEC-Q200**

AWCU00321619-02 Type

■ Dimensions / Recommended Land Pattern

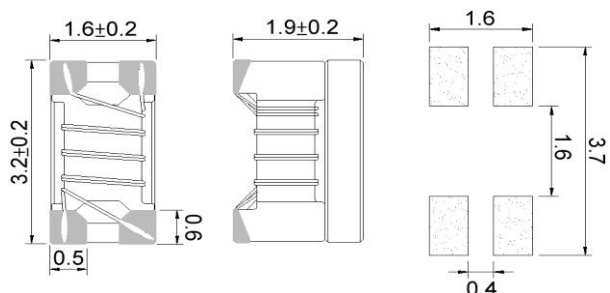

■ NO Polarity Equivalent circuit

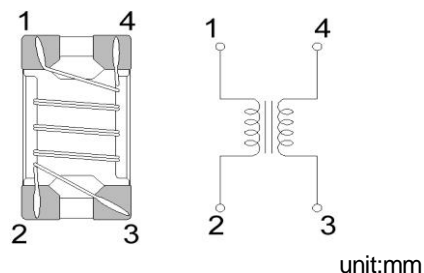

■ Electrical Characteristics

Part No.	Impedance (Ω)	Test Freq. (MHz)	RDC (Ω)Max.	IDC (mA)	Rated Voltage (Vdc)Max.	Withstanding Voltage (Vdc)	Insulation Resistance (MΩ)Min.	Tolerance (±%)
AWCU00321619900□02	90	100	0.3	370	50	125	10	20
AWCU00321619121□02	120	100	0.3	370	50	125	10	20
AWCU00321619161□02	160	100	0.4	340	50	125	10	20
AWCU00321619221□02	220	100	0.4	320	50	125	10	20
AWCU00321619261□02	260	100	0.5	310	50	125	10	20
AWCU00321619601□02	600	100	0.8	260	50	125	10	20
AWCU00321619102□02	1000	100	1	230	50	125	10	20
AWCU00321619222□02	2200	100	1.2	200	50	125	10	20

Note: When ordering, please specify tolerance code. Tolerance: M=±20%

1. Operating temperature range - 50°C ~ 150°C(Including self - temperature rise)
2. RDC: SINGLE WIRE TEST VALUE
3. IDC for Inductance drop 10% from its value without current.
4. Measure Equipment:
 Z: Agilent HP4287A+Agilent 16197A
 RDC: Chroma 16502 (Single Wire Test Value)
 IDC: HP4284A+HP42841A/HP4285A+HP42841A

Common Mode Choke AWCU Series

**Automotive
AEC-Q200**

AWCU00321619-02 Type

Characteristics Graph

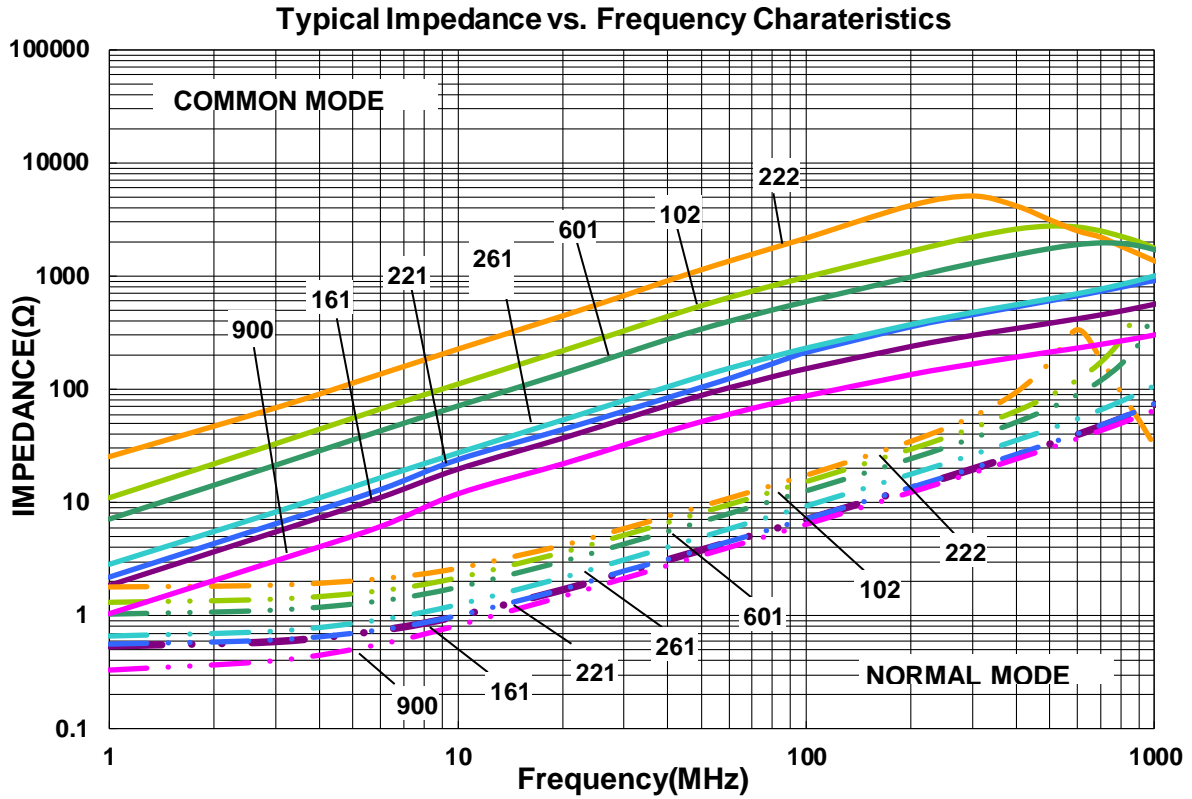

Common Mode Choke AWCU Series

**Automotive
AEC-Q200**

AWCU00332523 Type

■ Dimensions / Recommended Land Pattern

■ NO Polarity Equivalent circuit

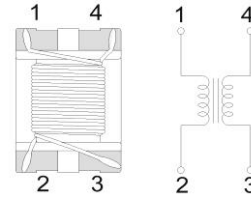
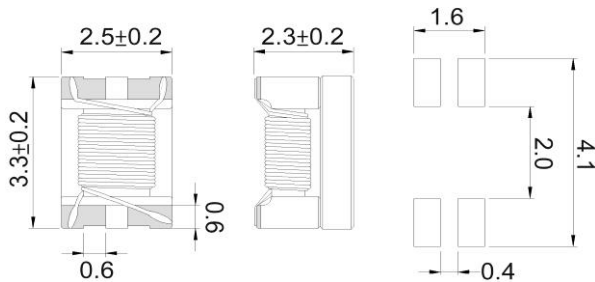

unit:mm

■ Electrical Characteristics

Part No.	Impedance (Ω)10MHz Min.(Typ.)	Inductance (uH)+50/-30	Stary Inductance (uH)Typ.	Test Freq.	RDC (Ω)Max.	Irms (mA)Max.	Rated Voltage (Vdc)Max.	Insulation Resistance (MΩ)Min.
AWCU00332523110XT2	300(550)	11	0.05	100kHz	0.4	300	80	10
AWCU00332523220XT2	500(1100)	22	0.06	100kHz	0.5	250	80	10
AWCU00332523510XT2	1000(2600)	51	0.09	100kHz	0.7	200	80	10
AWCU00332523101XT2	2200(5100)	100	0.13	100kHz	1.5	150	80	10

Note:

1. Operating temperature range - 50°C ~ 150°C(Including self - temperature rise)
2. RDC: SINGLE WIRE TEST VALUE
3. I rms for 15°C rise above 25°C ambient.
4. Measure Equipment:
 L: HP4284A+HP42841A/HP4285A+HP42841A
 RDC: CHROMA MILLIOM METER MODE 16502
 I rms: HP4284A+HP42841A/HP4285A+HP42841A
 Insulation Resistance: HP4339B

■ Electrical Characteristics

Part No.	Inductance (uH)+50/-30	Test Freq.	RDC (Ω)Max.	I rms (mA)Max.	Rated Voltage (Vdc)	Withstanding Voltage (Vdc)	Insulation Resistance (MΩ)Min.
AWCU00332523101XMF	100	100kHz	2.2	115	50	125	10

Note:

1. Operating temperature range - 40°C ~ 125°C(Including self - temperature rise)
2. RDC: SINGLE WIRE TEST VALUE
3. I rms for 15°C rise above 25°C ambient.
4. Measure Equipment:
 L: HP4284A+HP42841A/HP4285A+HP42841A
 RDC: CHROMA MILLIOM METER MODE 16502
 I rms: HP4284A+HP42841A/HP4285A+HP42841A
 Insulation Resistance: HP4339B

Common Mode Choke AWCU Series

**Automotive
AEC-Q200**

AWCU00332523 Type

Characteristics Graph

Typical Impedance vs. Frequency Charateristics

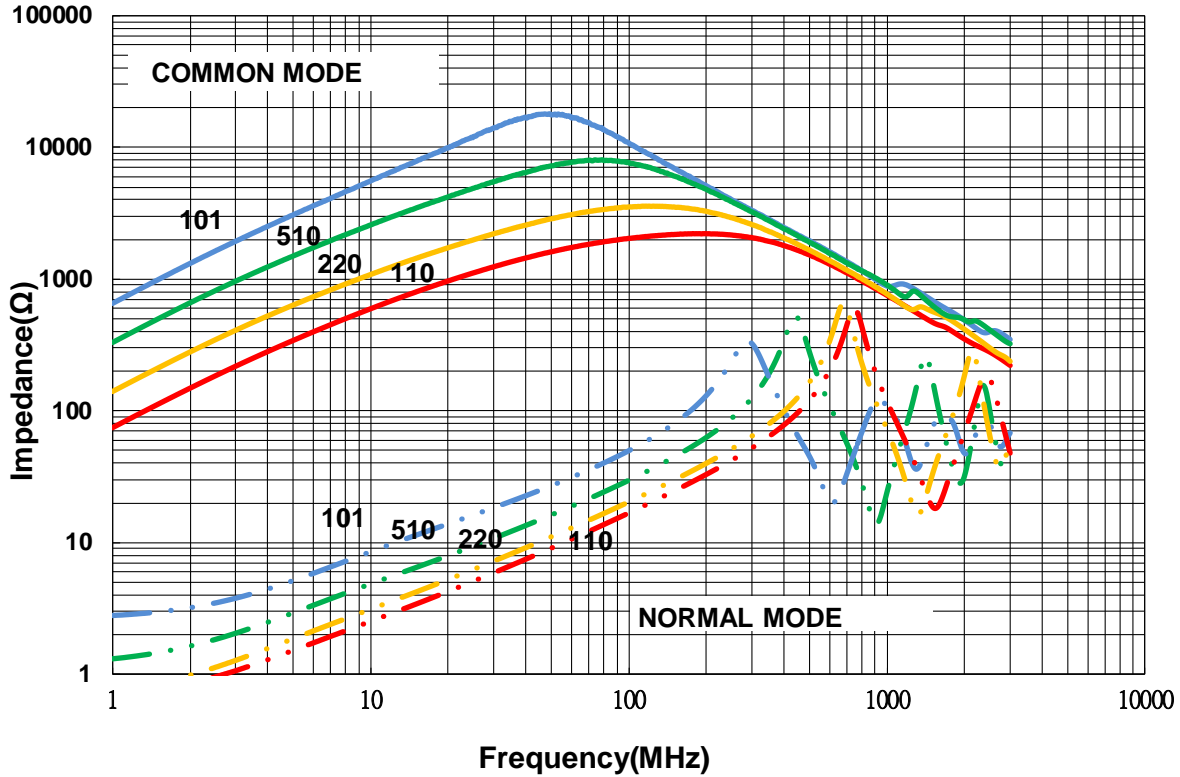

Typical Impedance vs. Frequency Charateristics

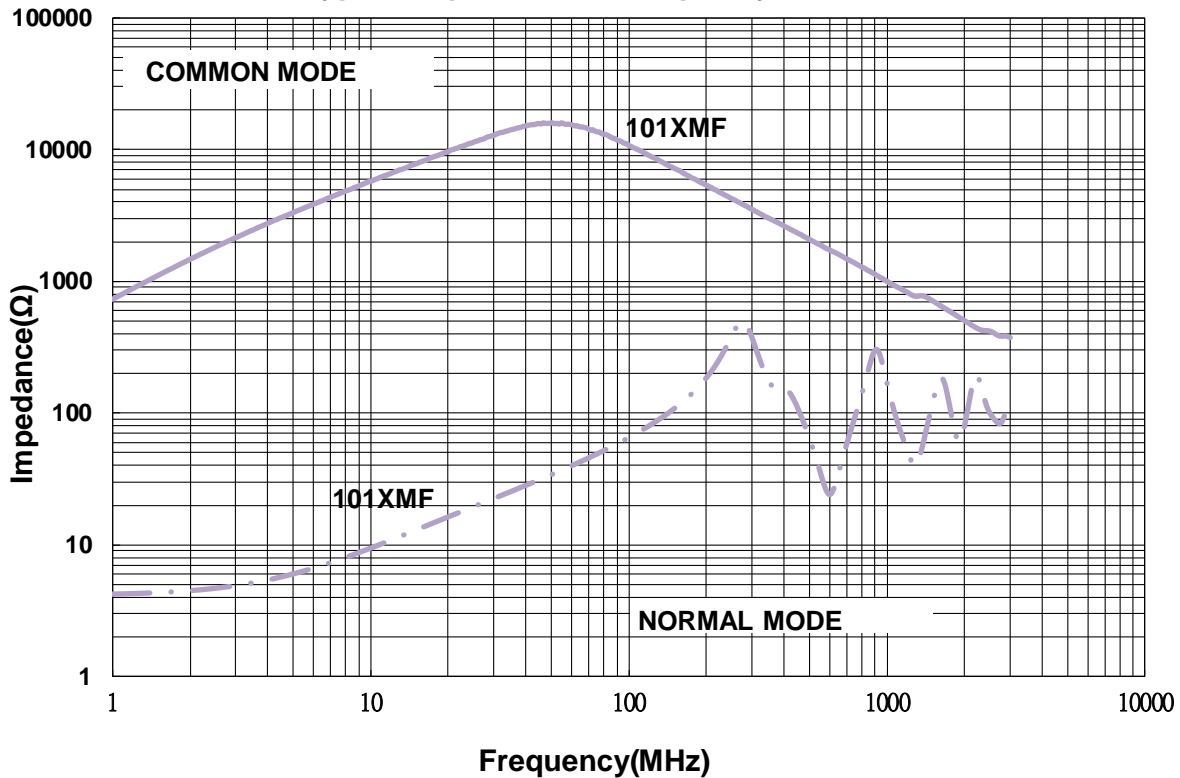

Please be sure to request approval specifications that provide further details of the products. Kindly note that the content of these specifications are subject to change or may be discontinued without prior notice. This product may not be designed/used in medical or high risk applications without Chilisin approval. Please contact our sales department before ordering.

Common Mode Choke AWCU Series

**Automotive
AEC-Q200**

AWCU00332525 Type

■ Dimensions / Recommended Land Pattern

■ NO Polarity Equivalent circuit

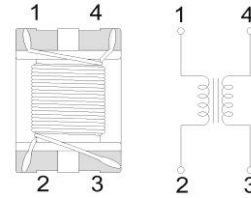
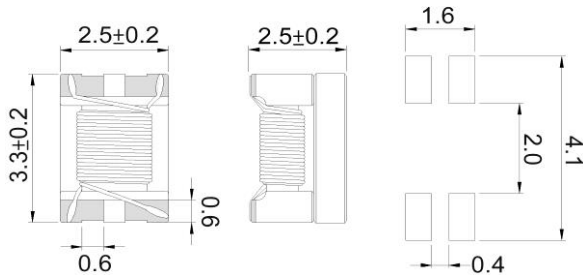

unit:mm

■ Electrical Characteristics

Part No.	Impedance (Ω)10MHz Min.(Typ.)	Inductance (uH)+50/-30	Stary Inductance (uH)Typ.	Test Freq.	RDC (Ω)Max.	Irms (mA)Max.	Rated Voltage (Vdc)Max.	Insulation Resistance (MΩ)Min.
AWCU00332525110XG0	300(550)	11	0.05	100kHz	0.4	300	80	10
AWCU00332525220XG0	500(1100)	22	0.06	100kHz	0.5	250	80	10
AWCU00332525510XG0	1000(2600)	51	0.09	100kHz	0.7	200	80	10
AWCU00332525101XG0	2200(5100)	100	0.13	100kHz	1.5	150	80	10

Note:

1. Operating temperature range - 50°C ~ 150°C(Including self - temperature rise)
2. RDC: SINGLE WIRE TEST VALUE
3. I_{rms} for 15°C rise above 25°C ambient.
4. Measure Equipment:
 L: HP4284A+HP42841A/HP4285A+HP42841A
 RDC: CHROMA MILLIOM METER MODE 16502
 I_{rms}: HP4284A+HP42841A/HP4285A+HP42841A
 Insulation Resistance: HP4339B

Common Mode Choke AWCU Series

Automotive
AEC-Q200

AWCU00332525 Type

Characteristics Graph

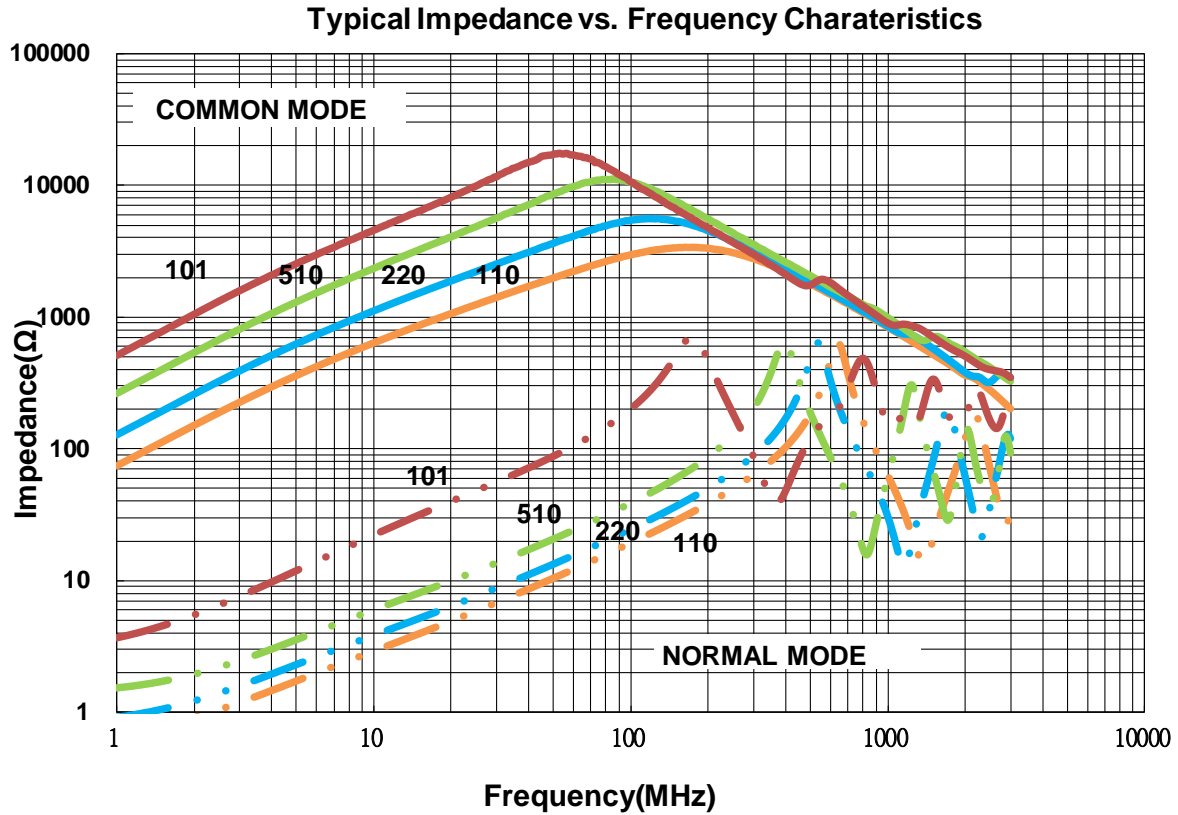

Common Mode Choke AWCU Series

**Automotive
AEC-Q200**

AWCU00453226-T2 Type

■ Dimensions/Recommended Land Pattern

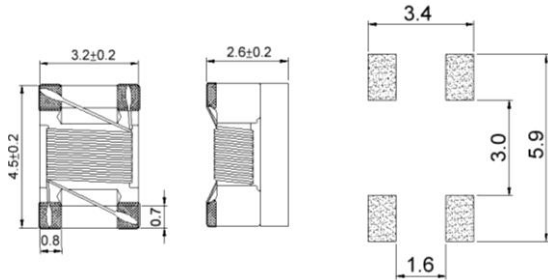

■ NO Polarity Equivalent circuit

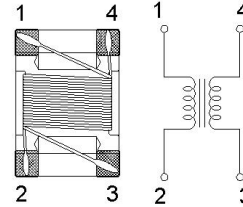

unit:mm

■ Electrical Characteristics

Part No.	Inductance (uH)	Test Freq.	Impedance (Ω)		Test Freq. (MHz)	RDC (Ω) Max.	I _{rms} (mA) Max.	Rated Voltage (Vdc)Max.	Withstanding Voltage (Vdc)	Insulation Resistance (MΩ)Min.	Tol. (±%)
			Min.	Typ.							
AWCU00453226113□T2	11	100kHz	300	600	10	0.6	250	50	125	10	30
AWCU00453226223□T2	22	100kHz	500	1200	10	1	200	50	125	10	30
AWCU00453226513□T2	51	100kHz	1000	2800	10	1	200	50	125	10	30
AWCU00453226104□T2	100	100kHz	2000	5800	10	2	150	50	125	10	30

Note: When ordering, please specify tolerance code. Tolerance: T=±30%

1. Operating temperature range - 50°C ~ 150°C(Including self - temperature rise)
2. RDC: SINGLE WIRE TEST VALUE
3. I_{rms} for 40°C rise above 25°C ambient.
4. Measure Equipment:
 Z: HP4286A / HP4287A / AgilentE4991A
 L: HP4284A+HP42841A/HP4285A+HP42841A
 RDC: CHROMA MILLIOM METER MODE 16502
 I_{rms}: HP4284A+HP42841A/HP4285A+HP42841A
 Insulation Resistance: HP4339B

Common Mode Choke AWCU Series

**Automotive
AEC-Q200**

AWCU00453226-T2 Type

Characteristics Graph

Typical Impedance vs. Frequency Characteristics

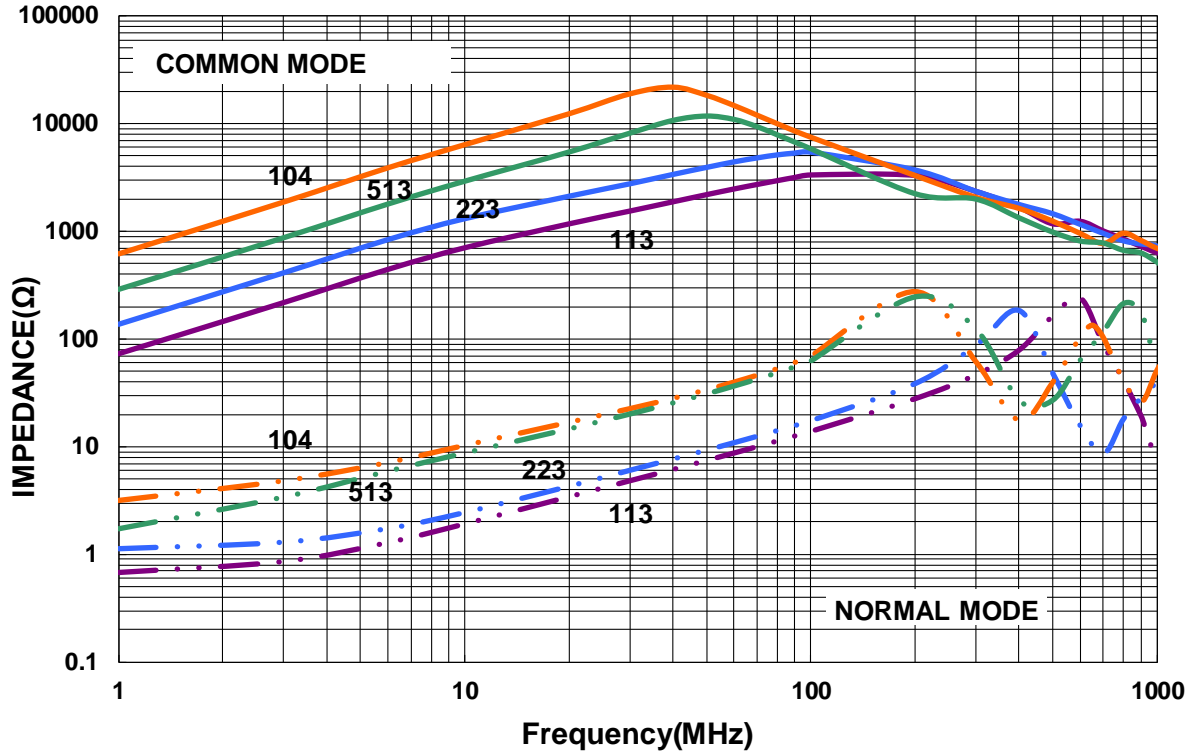

Common Mode Choke AWCU Series

**Automotive
AEC-Q200**

AWCU00453226-M2 Type

■ Dimensions/Recommended Land Pattern

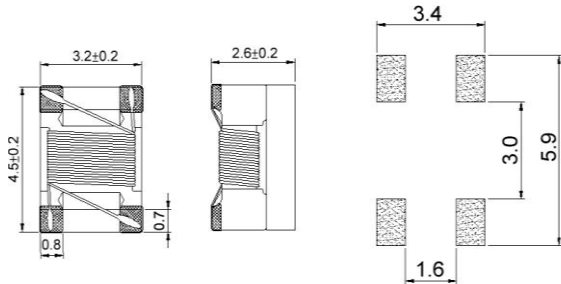

■ NO Polarity Equivalent circuit

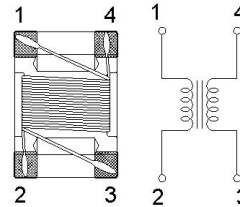

unit:mm

■ Electrical Characteristics

Part No.	Inductance (uH)	Test Freq.	RDC (Ω)Max.	I _{rms} (mA)Max.	Rated Voltage (Vdc)Max.	Withstanding Voltage (Vdc)	Insulation Resistance (MΩ)Min.	Tolerance (±%)
AWCU00453226113□M2	11	100kHz,100mV	0.5	360	50	125	10	30
AWCU00453226223□M2	22	100kHz,100mV	0.6	310	50	125	10	30
AWCU00453226513□M2	51	1MHz,200mV	1	230	50	125	10	30
AWCU00453226104□M2	100	1MHz,200mV	2	200	50	125	10	30

Note: When ordering, please specify tolerance code. Tolerance: T=±30%

1. Operating temperature range - 50°C ~ 150°C(Including self - temperature rise)
2. RDC: SINGLE WIRE TEST VALUE
3. I_{rms} for 40°C rise above 25°C ambient.
4. Measure Equipment:
 L: HP4284A+HP42841A/HP4285A+HP42841A
 RDC: CHROMA MILLIOM METER MODE 16502
 I_{rms}: HP4284A+HP42841A/HP4285A+HP42841A
 Insulation Resistance: HP4339B

Common Mode Choke AWCU Series

Automotive
AEC-Q200

AWCU00453226-M2 Type

■ Characteristics Graph

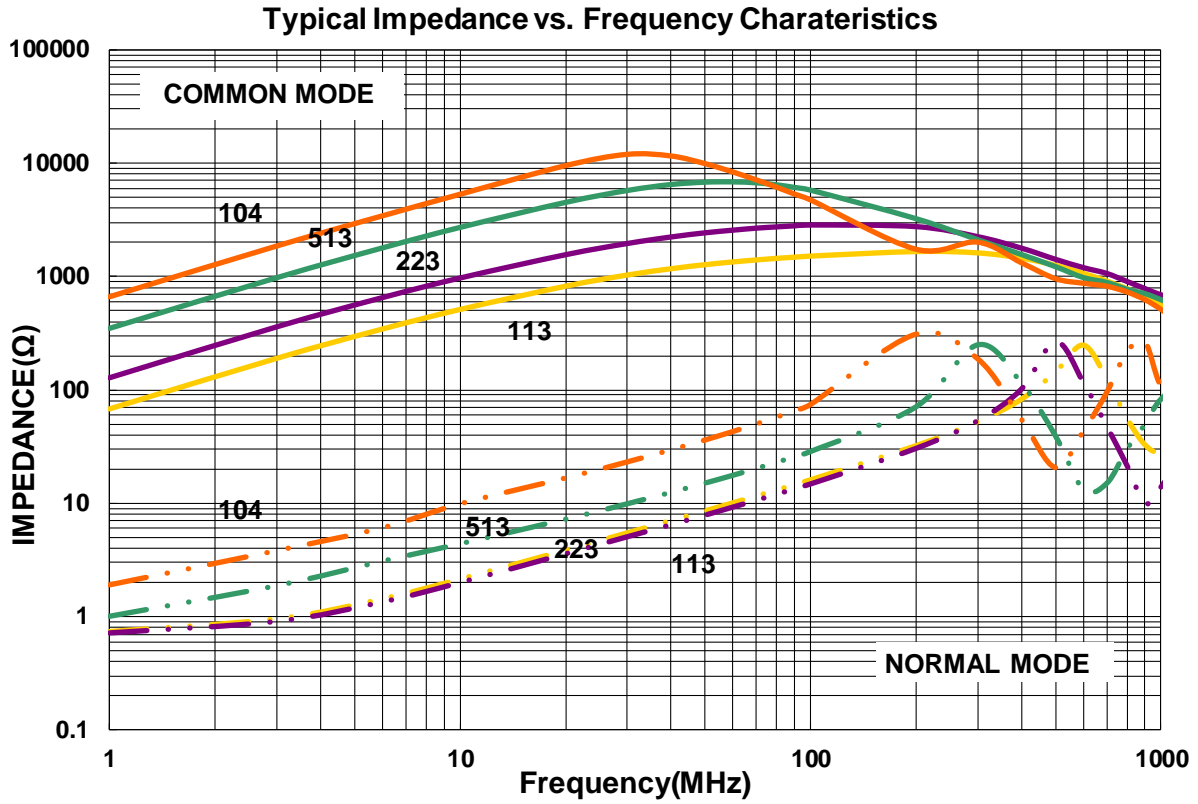

Common Mode Choke AWCU Series

**Automotive
AEC-Q200**

AWCU00453226-G0 Type

■ Dimensions / Recommended Land Pattern

■ NO Polarity Equivalent circuit

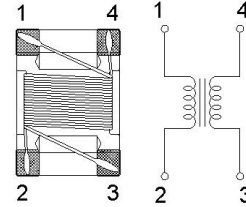
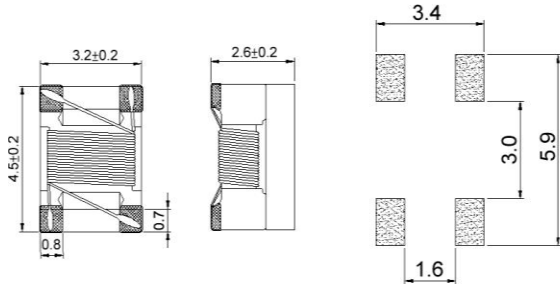

unit:mm

■ Electrical Characteristics

Part No.	Inductance1 (uH) 100kHz(50/-30%)	Inductance2 (uH) 1MHz(Typ.)	Impedance (Ω) 10MHz(Typ.)	RDC (Ω)Max.	Irms (mA)Max.	Rated Voltage (Vdc)Max.	Withstanding Voltage (Vdc)	Insulation Resistance (MΩ)Min.
AWCU00453226110XG0	11	-	670	0.5	360	50	125	10
AWCU00453226220XG0	22	-	1450	0.6	310	50	125	10
AWCU00453226510XG0	51	51	3500	1	230	50	125	10
AWCU00453226101XG0	100	100	6500	2	200	50	125	10

1. Operating temperature range - 50°C ~ 150°C(Including self - temperature rise)
2. RDC: SINGLE WIRE TEST VALUE
3. Irms for 40°C rise above 25°C ambient.
4. Measure Equipment:
 L: HP4284A+HP42841A/HP4285A+HP42841A
 RDC: CHROMA MILLIOM METER MODE 16502
 Irms: HP4284A+HP42841A/HP4285A+HP42841A
 Insulation Resistance: HP4339B

Common Mode Choke AWCU Series

**Automotive
AEC-Q200**

AWCU00453226-G0 Type

Characteristics Graph

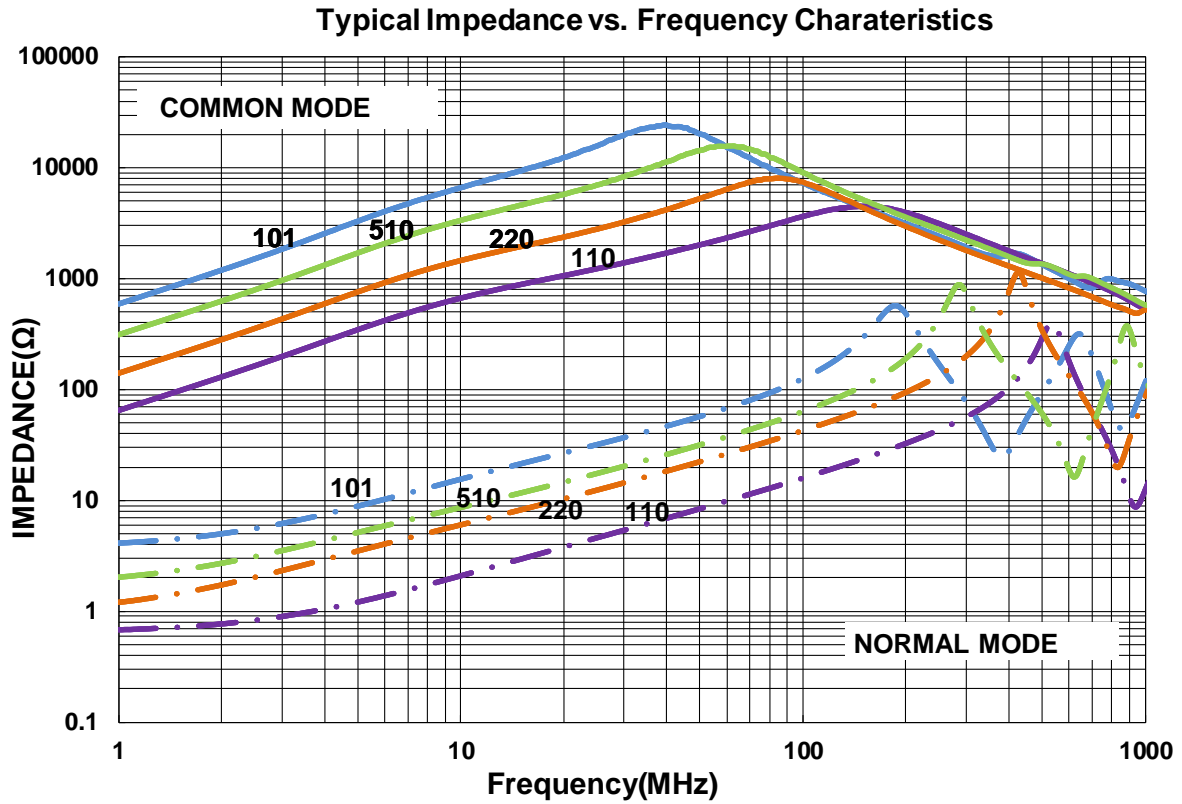

Common Mode Choke AWCU Series

**Automotive
AEC-Q200**

AWCU00453228 Type

■ Dimensions / Recommended Land Pattern

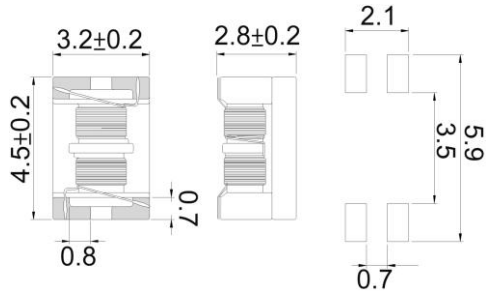

■ NO Polarity Equivalent circuit

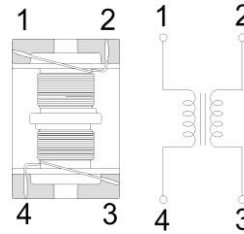

unit:mm

■ Electrical Characteristics

Part No.	Inductance (uH)+60/-20	Test Freq.	RDC (Ω)Max.	Irms (mA)Max.	Rated Voltage (Vdc)Max.	Insulation Resistance (MΩ)Min.
AWCU00453228201XTE	200	100kHz	4.5	100	50	10

Note:

1. Operating temperature range - 40°C ~ 125°C(Including self - temperature rise)
2. RDC: SINGLE WIRE TEST VALUE
3. I rms for 15°C rise above 25°C ambient.
4. Measure Equipment:
 L: HP4284A+HP42841A/HP4285A+HP42841A
 RDC: CHROMA MILLIOM METER MODE 16502
 I rms: HP4284A+HP42841A/HP4285A+HP42841A
 Insulation Resistance: HP4339B

Common Mode Choke AWCU Series

Automotive
AEC-Q200

AWCU00453228 Type

■ Characteristics Graph

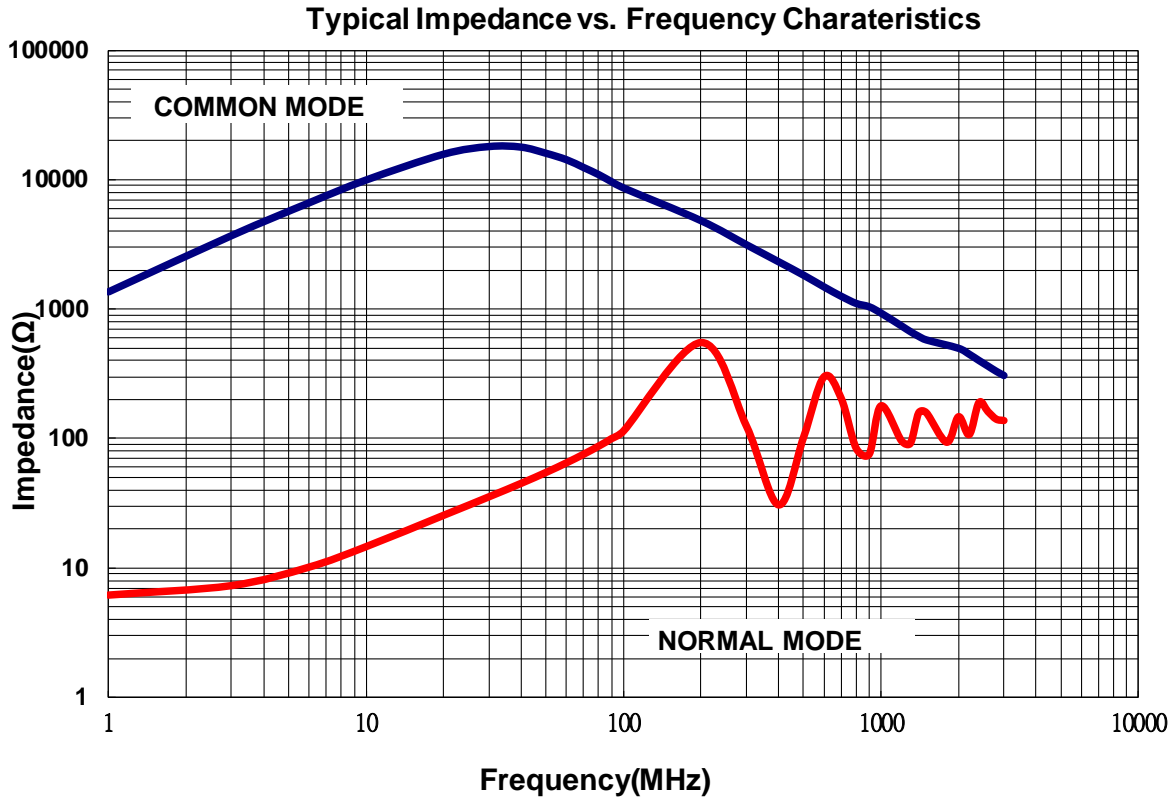

Common Mode Choke AWCU Series

**Automotive
AEC-Q200**

AWCU00201212-03 Type

■ Dimensions / Recommended Land Pattern

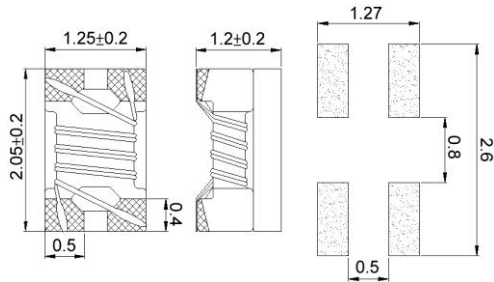

■ NO Polarity Equivalent circuit

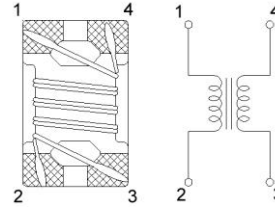

unit:mm

■ Electrical Characteristics

Part No.	Impedance (Ω)	Test Freq. (MHz)	RDC (Ω)Max.	IDC (mA)	Rated Voltage (Vdc)Max.	Withstanding Voltage (Vdc)	Insulation Resistance (MΩ)Min.	Tolerance (±%)
AWCU00201212500□03	50	100	0.2	500	50	125	10	25
AWCU00201212670□03	67	100	0.3	500	50	125	10	25
AWCU00201212900□03	90	100	0.3	500	50	125	10	25
AWCU00201212121□03	120	100	0.35	330	50	125	10	25

Note: When ordering, please specify tolerance code. Tolerance: Y=±25%

- Operating temperature range - 50°C ~ 150°C(Including self - temperature rise)
- RDC: SINGLE WIRE TEST VALUE
- IDC for Inductance drop 10% from its value without current.
- Measure Equipment:
 Z: Agilent HP4287A+Agilent 16197A
 RDC: Chroma 16502 (Single Wire Test Value)
 IDC: HP4284A+HP42841A/HP4285A+HP42841A

Common Mode Choke AWCU Series

Automotive
AEC-Q200

AWCU00201212-03 Type

■ Characteristics Graph

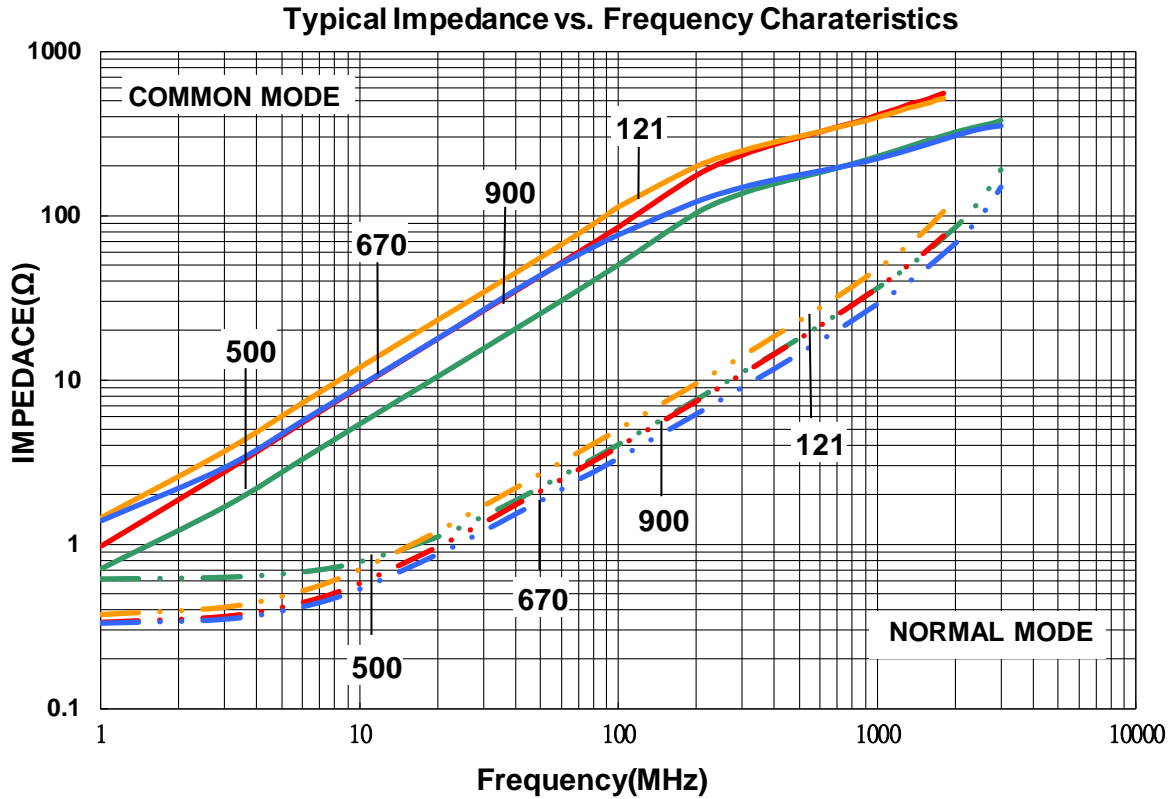

Common Mode Choke AWCU Series

Automotive
AEC-Q200

AWCU00201212500Y03

■ Insertion Loss For HDMI2.0 Testing:

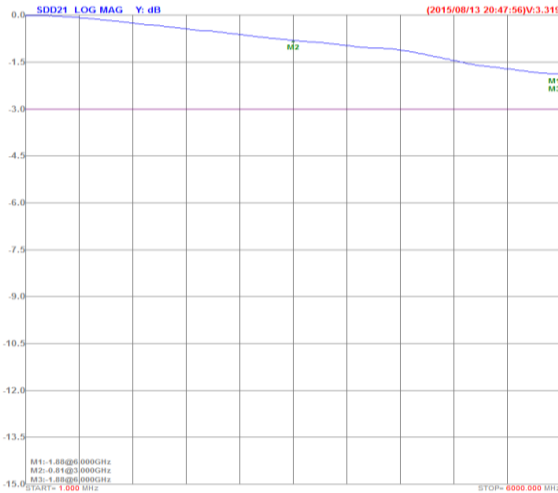

■ Insertion Loss For USB3.0 Testing:

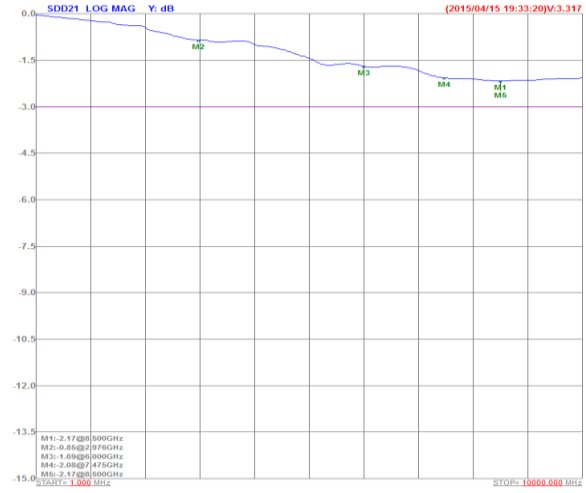

■ TDR For HDMI2.0 Testing:

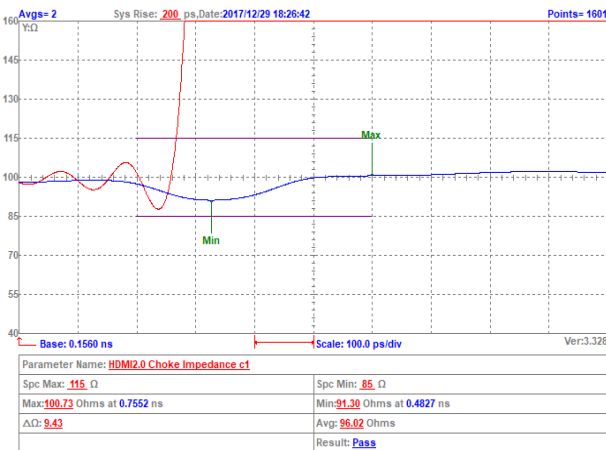

■ TDR For USB3.0 Testing:

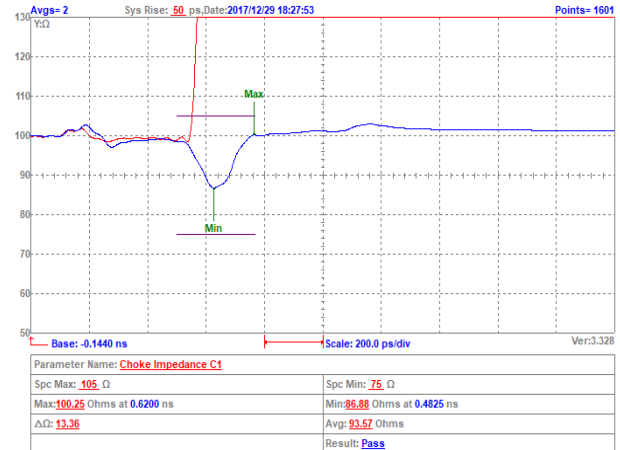

■ Eye Diagram For HDMI2.0 Testing:

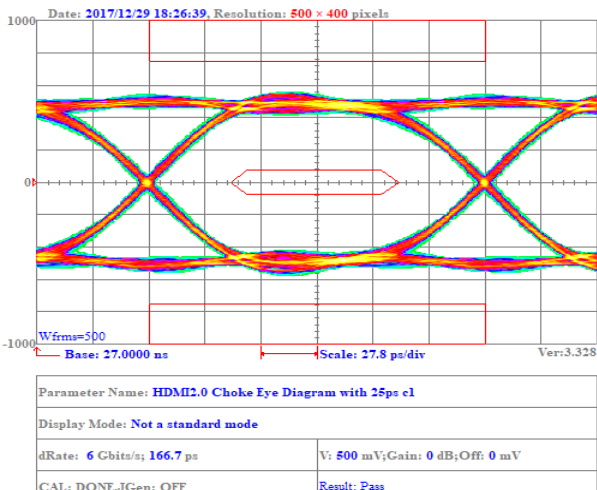

■ Eye Diagram For USB3.0 Testing:

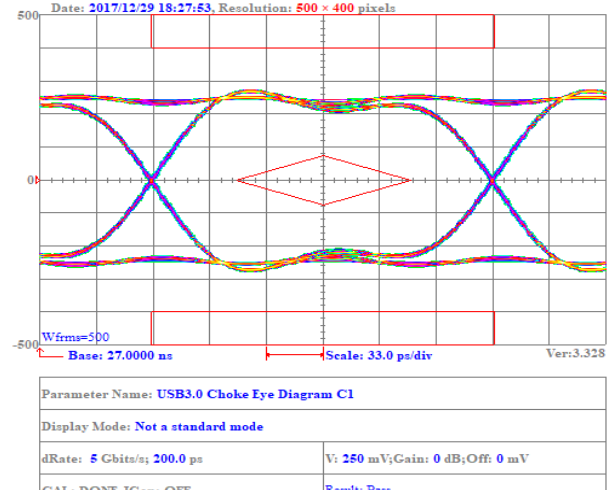

Please be sure to request approval specifications that provide further details of the products. Kindly note that the content of these specifications are subject to change or may be discontinued without prior notice. This product may not be designed/used in medical or high risk applications without Chilisin approval. Please contact our sales department before ordering.

Common Mode Choke AWCU Series

Automotive
AEC-Q200

AWCU00201212670Y03

Insertion Loss For HDMI2.0 Testing:

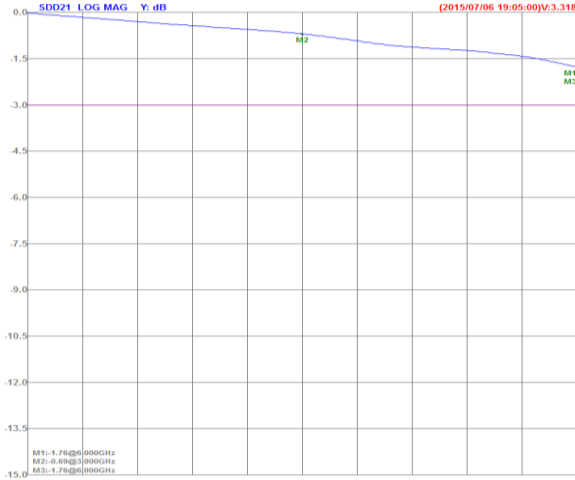

Insertion Loss For USB3.0 Testing:

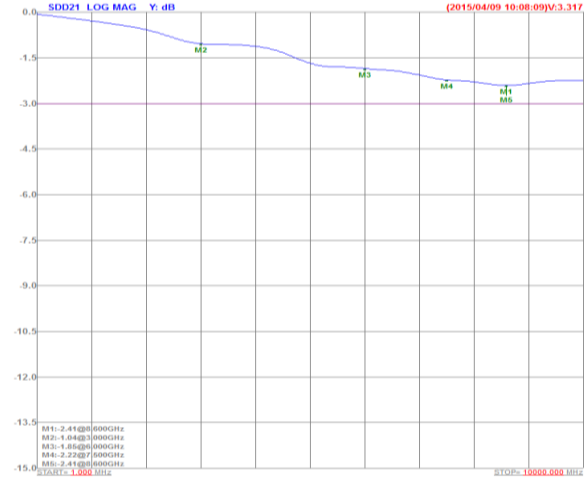

TDR For HDMI2.0 Testing:

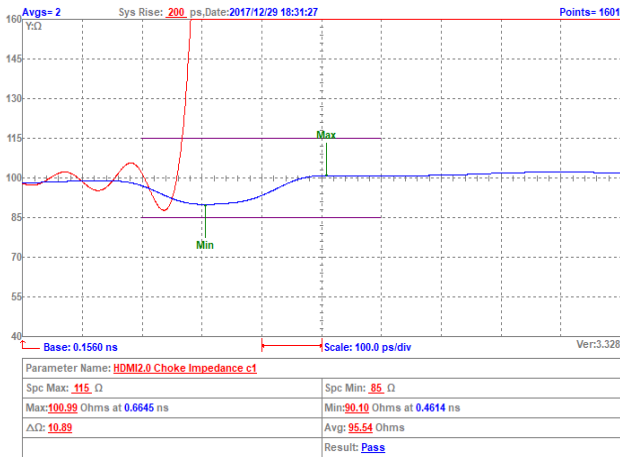

TDR For USB3.0 Testing:

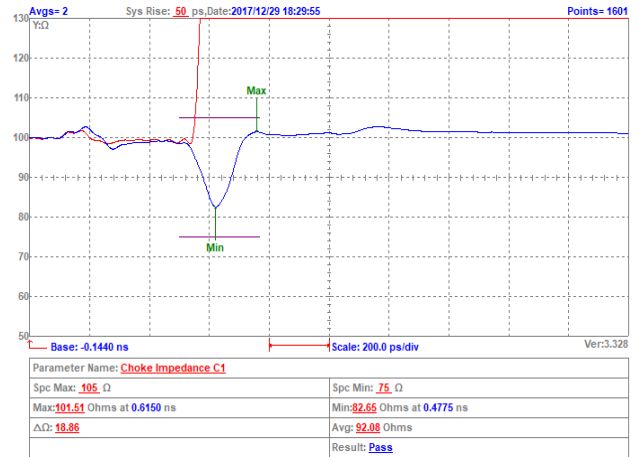

Eye Diagram For HDMI2.0 Testing:

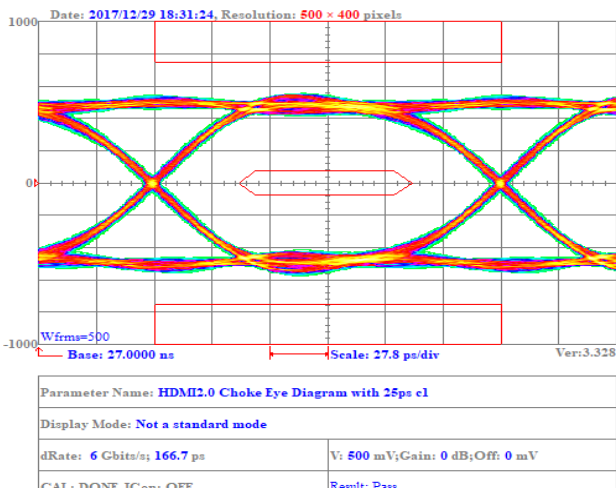

Eye Diagram For USB3.0 Testing:

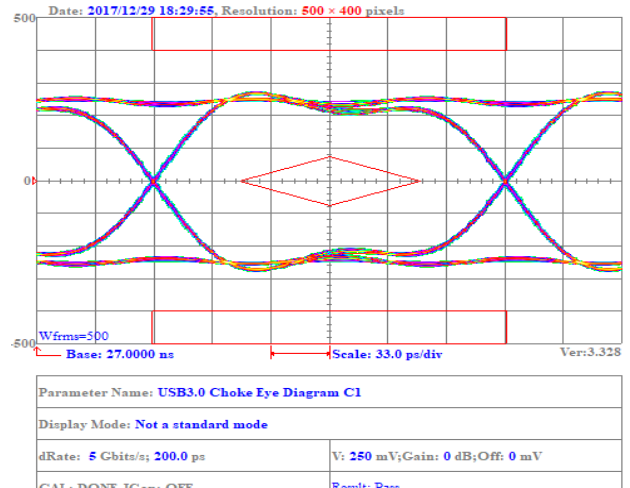

Please be sure to request approval specifications that provide further details of the products. Kindly note that the content of these specifications are subject to change or may be discontinued without prior notice. This product may not be designed/used in medical or high risk applications without Chilisin approval. Please contact our sales department before ordering.

Common Mode Choke AWCU Series

Automotive
AEC-Q200

AWCU00201212900Y03

Insertion Loss For HDMI2.0 Testing:

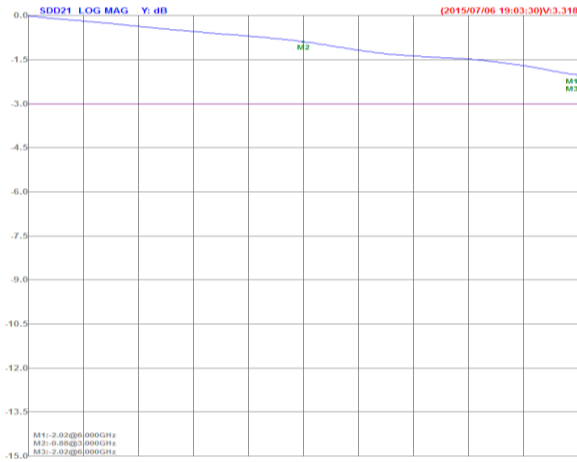

Insertion Loss For USB3.0 Testing:

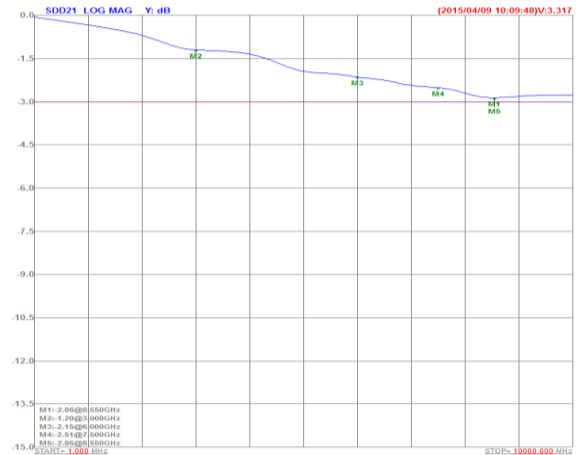

TDR For HDMI2.0 Testing:

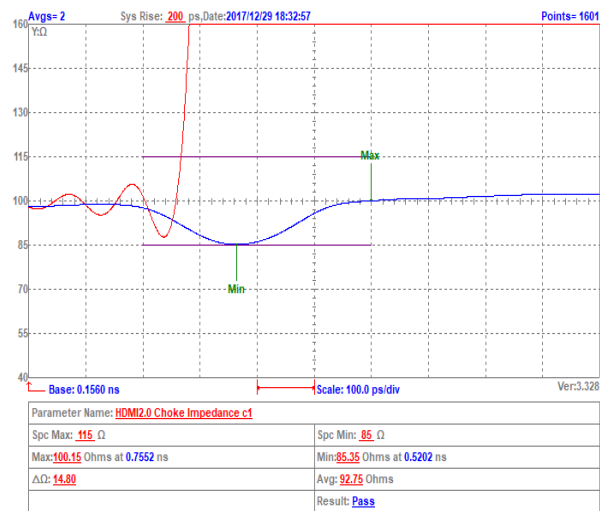

TDR For USB3.0 Testing:

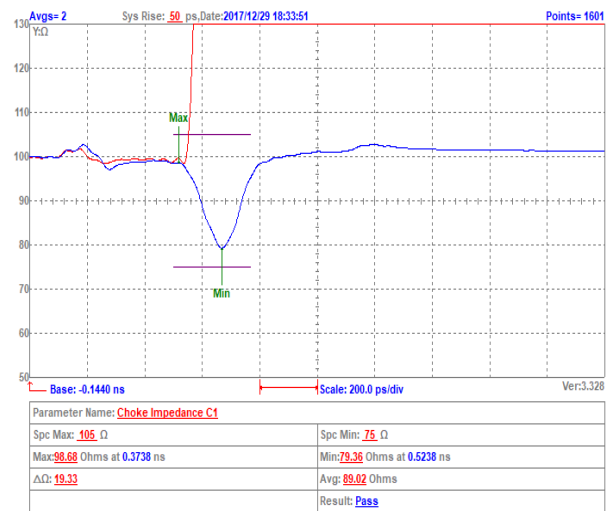

Eye Diagram For HDMI2.0 Testing:

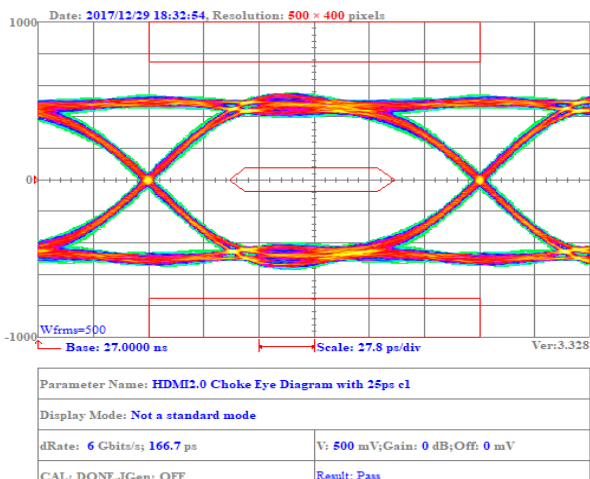

Eye Diagram For USB3.0 Testing:

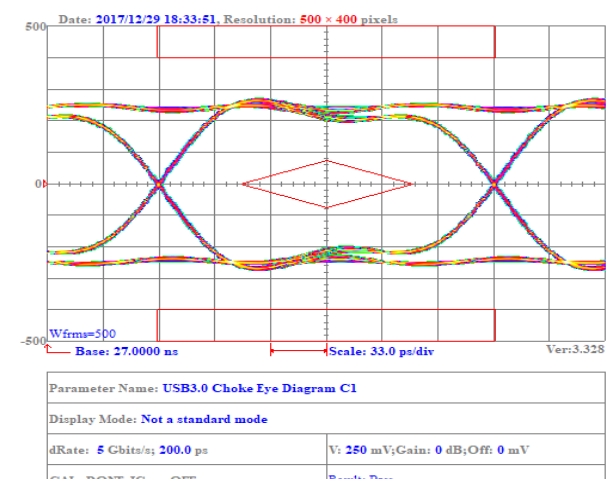

Please be sure to request approval specifications that provide further details of the products. Kindly note that the content of these specifications are subject to change or may be discontinued without prior notice. This product may not be designed/used in medical or high risk applications without Chilisin approval. Please contact our sales department before ordering.

Common Mode Choke AWCU Series

Automotive
AEC-Q200

AWCU00201212121Y03

Insertion Loss For HDMI2.0 Testing:

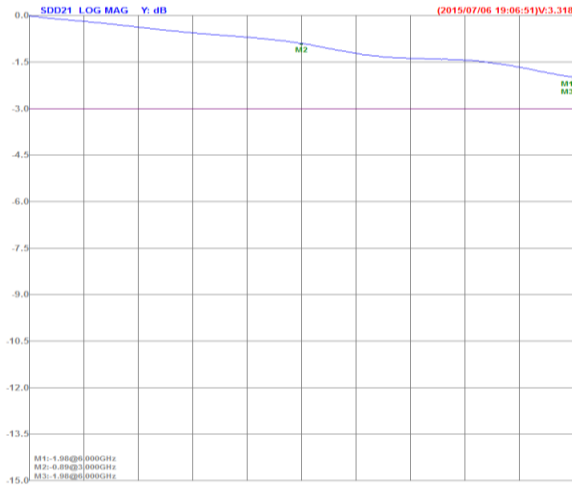

Insertion Loss For USB3.0 Testing:

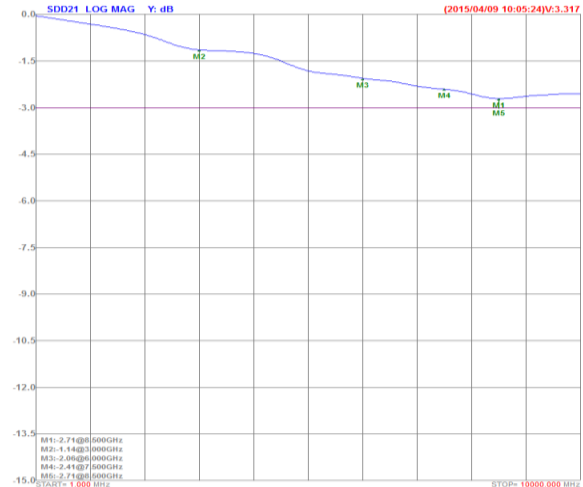

TDR For HDMI2.0 Testing:

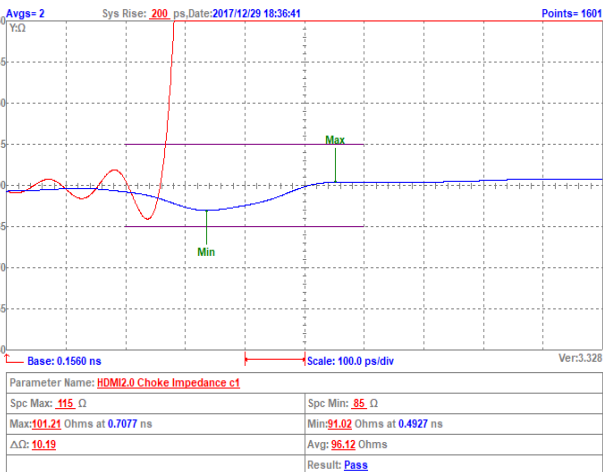

TDR For USB3.0 Testing:

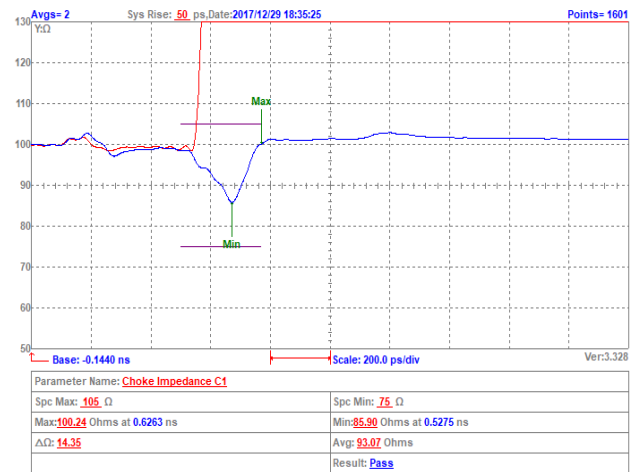

Eye Diagram For HDMI2.0 Testing:

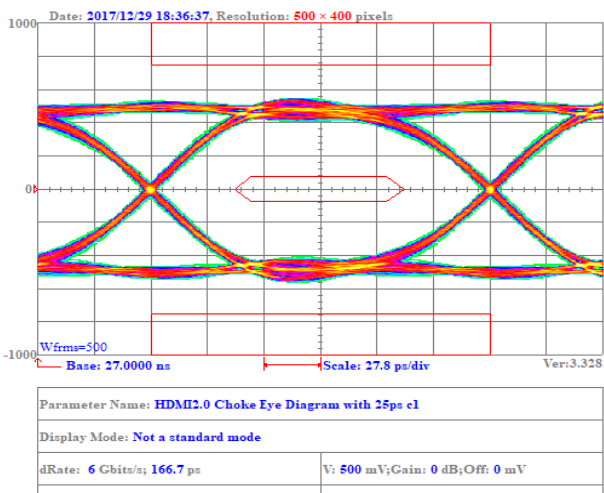

Eye Diagram For USB3.0 Testing:

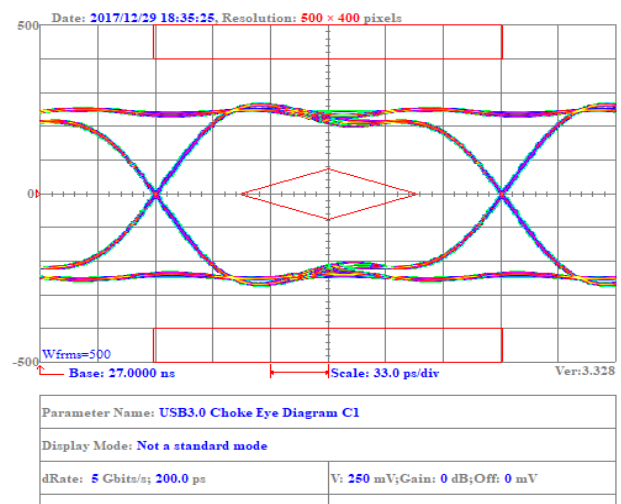

Please be sure to request approval specifications that provide further details of the products. Kindly note that the content of these specifications are subject to change or may be discontinued without prior notice. This product may not be designed/used in medical or high risk applications without Chilisin approval. Please contact our sales department before ordering.

Common Mode Choke AWCU Series

**Automotive
AEC-Q200**

■ Packaging

Tape Dimensions

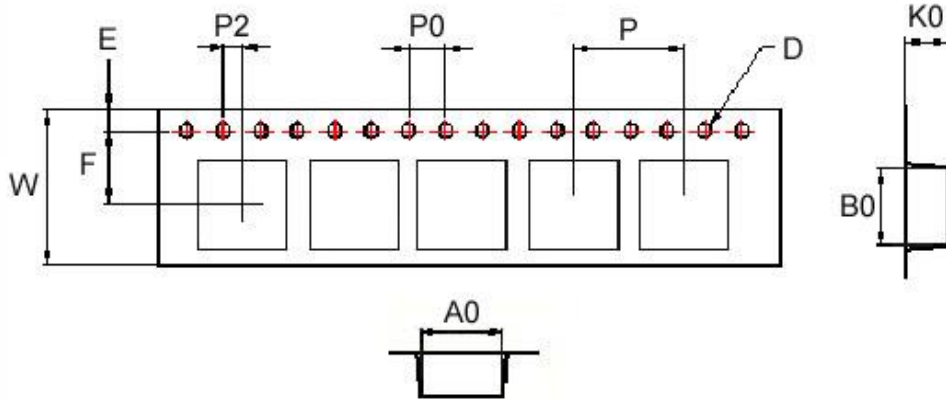

Reel Dimensions

Figure1

Figure 2

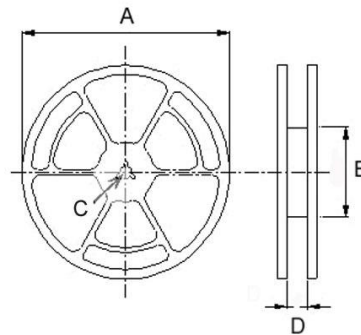
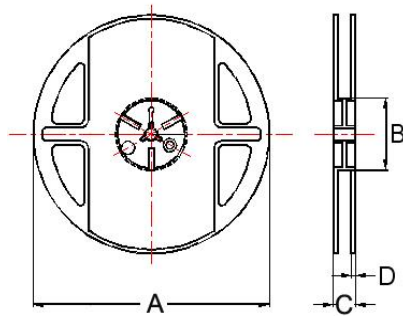

Dimensions in mm

TYPE	Tape Dimensions										Reel Dimensions				Quantity PCS/REEL	
	A0	B0	K0	D	E	F	W	P	P0	P2	Fig.	A	B	C		D
AWCU00201212	1.5	2.25	1.45	1.5	1.75	3.5	8	4	2	2	1	178	60	12	1.5	2000
AWCU00321619	1.76	3.47	2.05	1.5	1.75	3.5	8	4	2	2	1	178	60	12	1.5	2000
AWCU00332523	2.72	3.52	2.45	1.5	1.75	5.5	12	4	4	2	1	178	60	12	1.5	1500
AWCU00332525	2.72	3.52	2.60	1.5	1.75	5.5	12	4	4	2	1	178	60	12	1.5	1500
AWCU00453226	3.6	4.9	3	1.5	1.75	5.5	12	8	4	2	2	330	100	13	13.4	2500
AWCU00453228	3.6	4.9	3	1.5	1.75	5.5	12	8	4	2	2	330	100	13	13.4	2500