

## BWHH Series



Due to accurate wire winding technology, these chip inductors are designed for filtering, impedance matching, resonance and choke circuits for RF designer. Both standard series custom designs are available.

### Features

- RoHS Compliant and Halogen Free
- Ceramic body and wire wound construction provide high Q and SRFs
- Higher Q and lower DCR than other inductors
- Exceptional current handling capability
- HPH series is for high power and high frequency application

### Applications

- Wireless embedded portable devices
- GPS receiver
- Base Station
- Repeater
- Set Top Box
- Cable / IP Modem
- Security system and other RF modules

### Product Identification

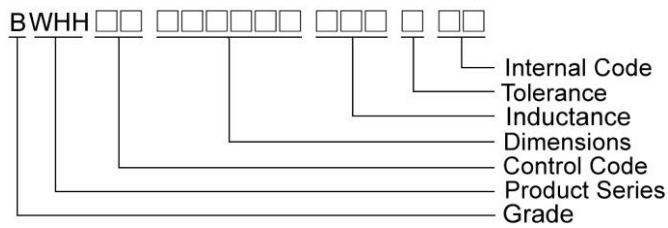

### Shape and Dimensions / Recommended Pattern

**BWHH00161108**

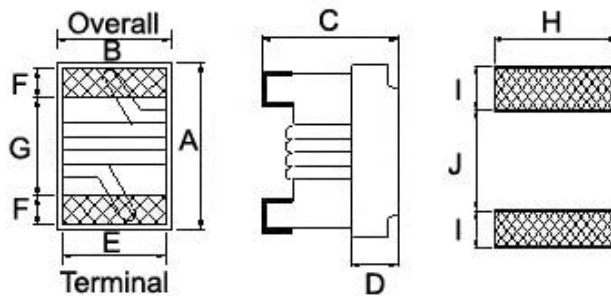

Dimensions

	A	B	C	D	E	F	G	H	I	J
<b>BWHH00161108</b>	1.6 <sup>+0.2</sup> <sub>-0.1</sub>	1.12 ± 0.1	0.82 <sup>+0.2</sup> <sub>-0.1</sub>	0.30	0.70	0.30	0.95	1.02	0.64	0.64

# SMD Wire Wound Ceramic Chip Inductors - BWHH Series

## Electrical Characteristics

Part Number	Inductance (nH)	Tolerance (±%)	Test Frequency (MHz)	Q Typ.	Test Frequency (MHz)	SRF (GHz) Typ.	RDC (Ω) Max	Irms (mA) Max	Color Code
BWHH001611083N3□00	3.3	5 / 3	250	36	250	9.6	0.034	1900	Black
BWHH001611083N6□00	3.6	5 / 3	250	28	250	9.7	0.040	1900	Brown
BWHH001611085N1□00	5.1	5 / 3	250	38	250	8.9	0.042	1700	Red
BWHH001611085N6□00	5.6	5 / 3	250	35	250	6.6	0.042	1700	Orange
BWHH001611086N0□00	6.0	5 / 3	250	49	250	6.0	0.042	1700	Yellow
BWHH001611088N2□00	8.2	5 / 3	250	40	250	5.9	0.054	1400	Green
BWHH001611088N7□00	8.7	5 / 3	250	46	250	5.5	0.054	1400	Blue
BWHH001611089N1□00	9.1	5 / 3	250	40	250	5.1	0.052	1400	Violet
BWHH001611089N5□00	9.5	5 / 3	250	42	250	4.9	0.054	1400	Gray
BWHH0016110810N□00	10	5 / 3	250	44	250	4.3	0.054	1400	White
BWHH0016110812N□00	12	5 / 3	250	40	250	4.1	0.088	1100	Black
BWHH0016110818N□00	18	5 / 3	250	45	250	3.3	0.082	1200	Brown

**Note:** When ordering, please specify tolerance code. Tolerance : H=±3% , J=±5%

- Operating temperature range - 40°C ~ 125°C(Including self - temperature rise)
- I<sub>rms</sub> for a 15°C temperature rise from 25°C ambient with current
- Measure Equipment :  
 L & Q : Agilent E4991A+Agilent HP16197A  
 SRF : Agilent E5071C  
 RDC : Chroma 16502  
 I<sub>rms</sub> : HP4284A+HP42841A/HP4285A+HP42841A

Typical **L** vs. **F** Frequency

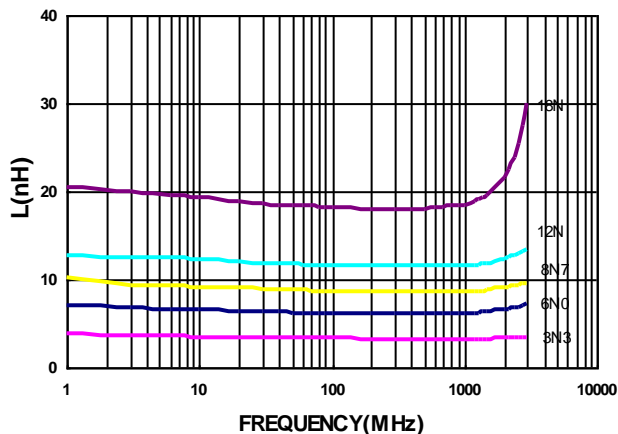

Typical **Q** vs. **F** Frequency

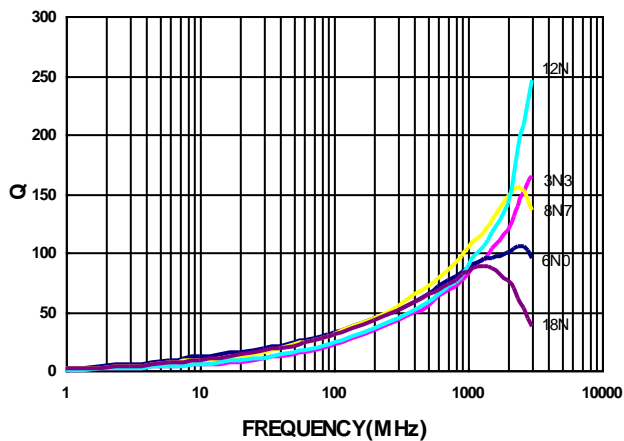

# SMD Wire Wound Ceramic Chip Inductors - BWHH Series

## Packaging Specifications

Tape Dimensions

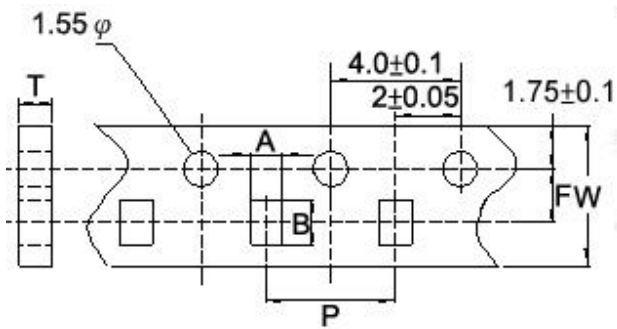

Tape Material

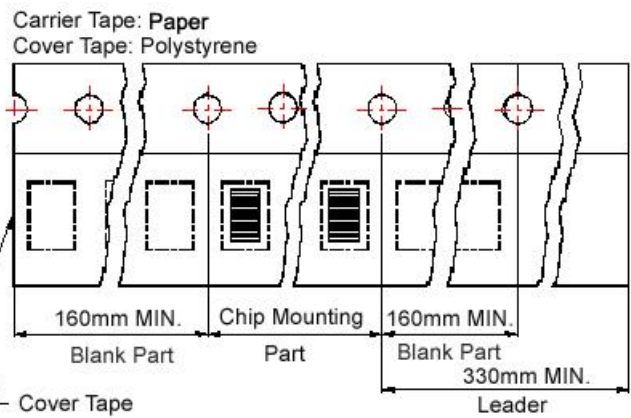

Reel Dimensions

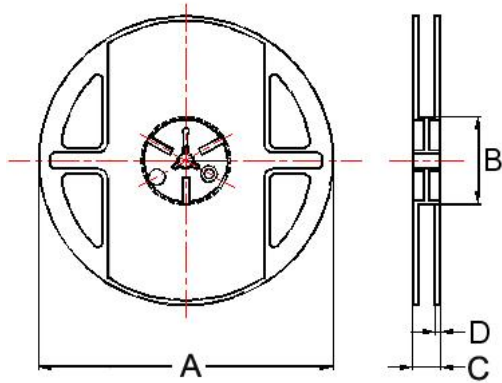

## Dimensions in mm

TYPE	Tape Dimensions						Reel Dimensions				Quantity PCS / Reel
	A	B	T	W	P	F	A	B	C	D	
BWHH00161108	1.25	1.90	1.05	8	4	3.5	178	60	12	1.5	4000