

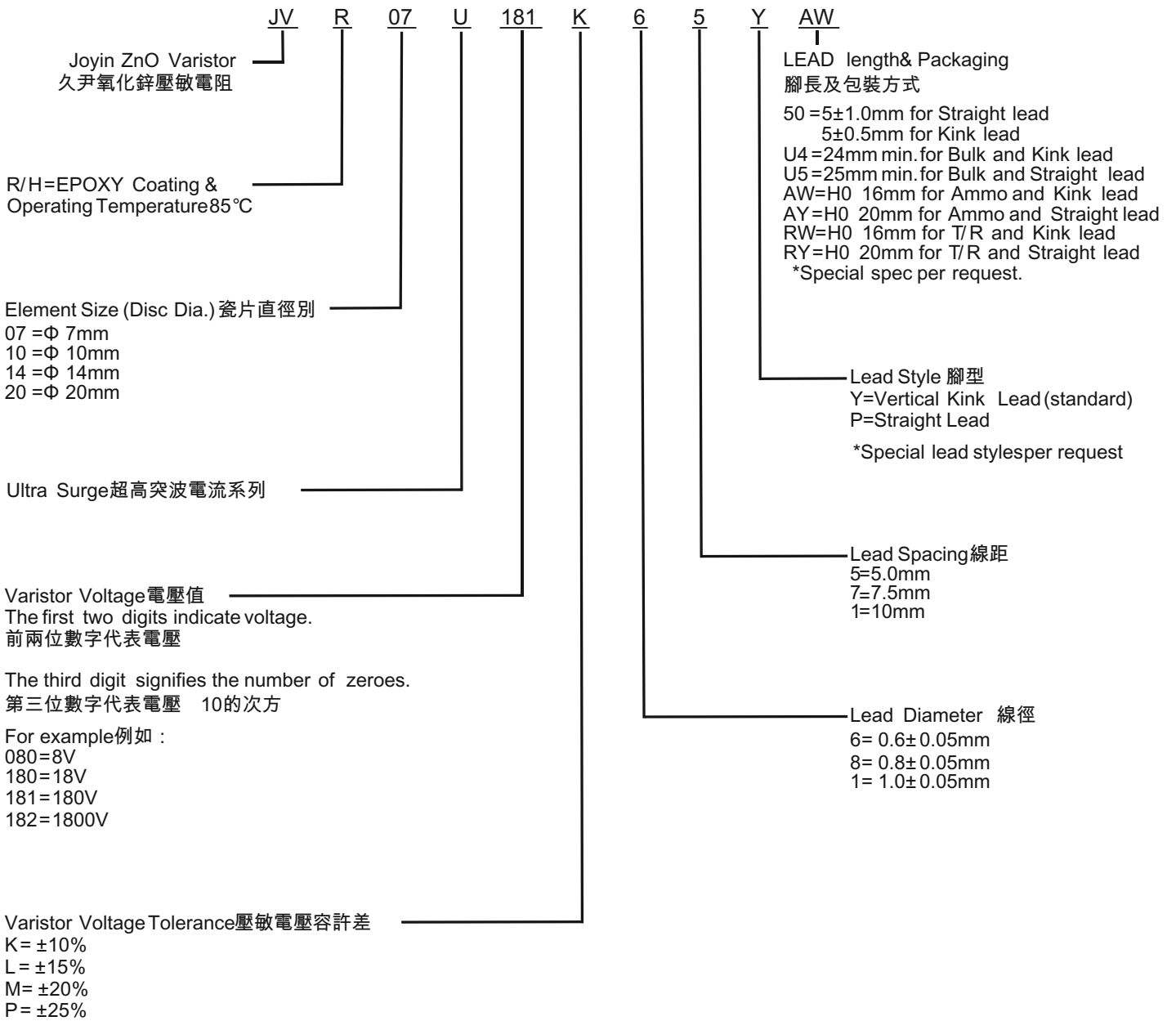

ORDERING CODE



過電壓保護

Application notes for UL, CSA, VDE and CQC reconized related standards

Standard NO.	UL	CUL	VDE		CQC	
	UL 1449 4 <sup>TH</sup> Edition	CSA22.2 No. 269.5	IEC61051-1 IEC61051-2 IEC61051-2-2	IEC61051-1 IEC61051-2 IEC61051-2-2 IEC60950-1:2013 Annex Q IEC62368-1:2014 / G.8.2	GB/T1093-1997 GB/T10194-1997	GB4943.1-2011 GB/T1093-1997 GB/T10194-1997 GB8898-2011
Title	Transient Voltage Surge Suppressors	Transient Voltage Surge Suppressors	Varistors for use in electronic equipment		Engaged in Voluntary Product Certification	
Certificate No.	VZCA2.E325508	VZCA8.E325508	40046994		CQC07001019159/9161/9162/9163/9164	
Symbols	☆		*	★	☆	★



RATING AND CHARACTERISTICS

Ultra Surge Varistors - 7mm

Part No.	Varistor Voltage at 1mA		Maximum Allowable Voltage		Maximum Clamping Voltage		Withstanding Surge Current (8/20us)	Nominal Discharge Current (8/20us)	Rated Wattage	Energy (10/1000us)	Certification		
	DC (V)	Tolerance	AC rms (V)	DC (V)	V@ ic (V)	ic (A)	1 Time (A)	In (kA)	(W)	(J)	UL	US	CEC
JVR 07U 181K	180	±10%	115	150	300	100	1800	1	0.25	19.0	☆	☆	☆
JVR 07U 201K	200	±10%	130	170	340	100	1800	1	0.25	21.0	☆	☆	☆
JVR 07U 221K	220	±10%	140	180	360	100	1800	1	0.25	23.0	☆	☆	☆
JVR 07U 241K	240	±10%	150	200	395	100	1800	1	0.25	25.0	☆	☆	☆
JVR 07U 271K	270	±10%	175	225	455	100	1800	1	0.25	28.0	☆	☆	☆
JVR 07U 301K	300	±10%	195	250	505	100	1800	1	0.25	32.0	☆	☆	☆
JVR 07U 331K	330	±10%	210	275	550	100	1800	1	0.25	34.0	☆	☆	☆
JVR 07U 361K	360	±10%	230	300	595	100	1800	1	0.25	37.0	☆	☆	☆
JVR 07U 391K	390	±10%	250	320	650	100	1800	1.0	0.25	40.0	☆	☆	☆
JVR 07U 431K	430	±10%	275	350	710	100	1800	1.0	0.25	46.0	☆	☆	☆
JVR 07U 471K	470	±10%	300	385	775	100	1800	1.0	0.25	49.0	☆	☆	☆
JVR 07U 511K	510	±10%	320	418	842	100	1800	1.0	0.25	54.0	☆	☆	☆
JVR 07U 561K	560	±10%	350	460	920	100	1800	1.0	0.25	55.0	☆	☆	☆
JVR 07U 621K	620	±10%	385	505	1025	100	1800	1.0	0.25	59.0	☆	☆	☆
JVR 07U 681K	680	±10%	420	560	1120	100	1800	1.0	0.25	62.0	☆	☆	☆
JVR 07U 751K	750	±10%	460	615	1240	100	1800	1.0	0.25	66.0	☆	☆	☆
JVR 07U 781k	780	±10%	485	640	1290	100	1800	1.0	0.25	68	☆	☆	☆
JVR 07U 821k	820	±10%	510	670	1355	100	1800	1.0	0.25	71.0	☆	☆	☆

過電壓保護

Pulse Life time Ratings - 7mm  
07U 181K-07U 821K

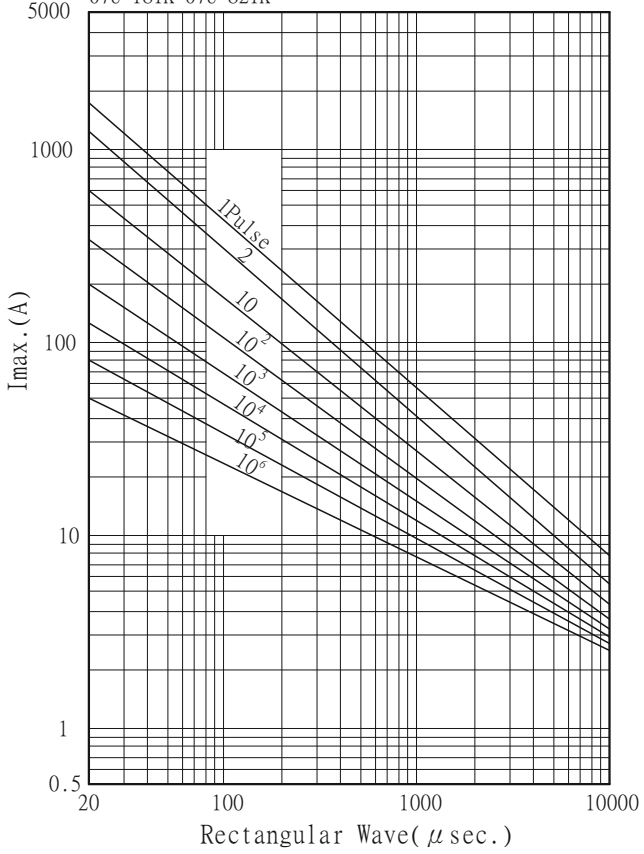

V-I Characteristic Curve - 7mm  
07U 181K-07U 821K

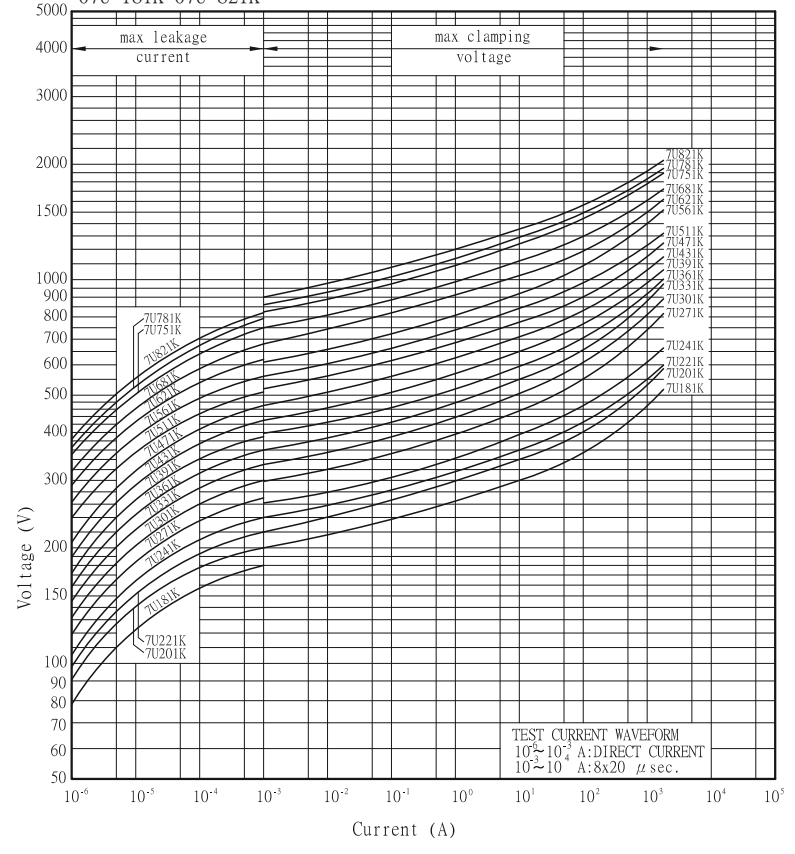

All specification is base on datasheets and subject to change without notice.



RATING AND CHARACTERISTICS

Ultra Surge Varistors - 10mm

Part No.	Varistor Voltage at 1mA		Maximum Allowable Voltage		Maximum Clamping Voltage		Withstanding Surge Current (8/20us)	Nominal Discharge Current (8/20us)	Rated Wattage	Energy (10/1000us)	Certification		
	DC (V)	Tolerance	AC rms (V)	DC (V)	V@ ic (V)	ic (A)					1 Time (A)	In (kA)	(W)
JVR 10U 181K	180	±10%	115	150	300	100	4500	3	0.4	47.0	★	★	★
JVR 10U 201K	200	±10%	130	170	340	100	4500	3	0.4	52.0	★	★	★
JVR 10U 221K	220	±10%	140	180	360	100	4500	3	0.4	58.0	★	★	★
JVR 10U 241K	240	±10%	150	200	395	100	4500	3	0.4	64.0	★	★	★
JVR 10U 271K	270	±10%	175	225	455	100	4500	3	0.4	67.0	★	★	★
JVR 10U 301K	300	±10%	195	250	505	100	4500	3	0.4	70.0	★	★	★
JVR 10U 331K	330	±10%	210	275	550	100	4500	3	0.4	72.0	★	★	★
JVR 10U 361K	360	±10%	230	300	595	100	4500	3	0.4	76.0	★	★	★
JVR 10U 391K	390	±10%	250	320	650	100	4500	3.0	0.4	82.0	★	★	★
JVR 10U 431K	430	±10%	275	350	710	100	4500	3.0	0.4	93.0	★	★	★
JVR 10U 471K	470	±10%	300	385	775	100	4500	3.0	0.4	99.0	★	★	★
JVR 10U 511K	510	±10%	320	418	842	100	4500	3.0	0.4	107.0	★	★	★
JVR 10U 561K	560	±10%	350	460	920	100	4500	3.0	0.4	113.0	★	★	★
JVR 10U 621K	620	±10%	385	505	1025	100	4500	3.0	0.4	125.0	★	★	★
JVR 10U 681K	680	±10%	420	560	1120	100	4500	3.0	0.4	128.0	★	★	★
JVR 10U 751K	750	±10%	460	615	1240	100	4500	3.0	0.4	134	★	★	★
JVR 10U 781k	780	±10%	485	640	1290	100	4500	3.0	0.4	139	★	★	★
JVR 10U 821k	820	±10%	510	670	1355	100	4500	3.0	0.4	146.0	★	★	★
JVR 10U 911k	910	±10%	550	745	1500	100	4500	3.0	0.4	152	★	★	★
JVR 10U 102K	1000	±10%	625	825	1650	100	4500	3.0	0.4	170	★	★	★
JVR 10U 112K	1100	±10%	680	895	1815	100	4500	3.0	0.4	180	★	★	★

過電壓保護

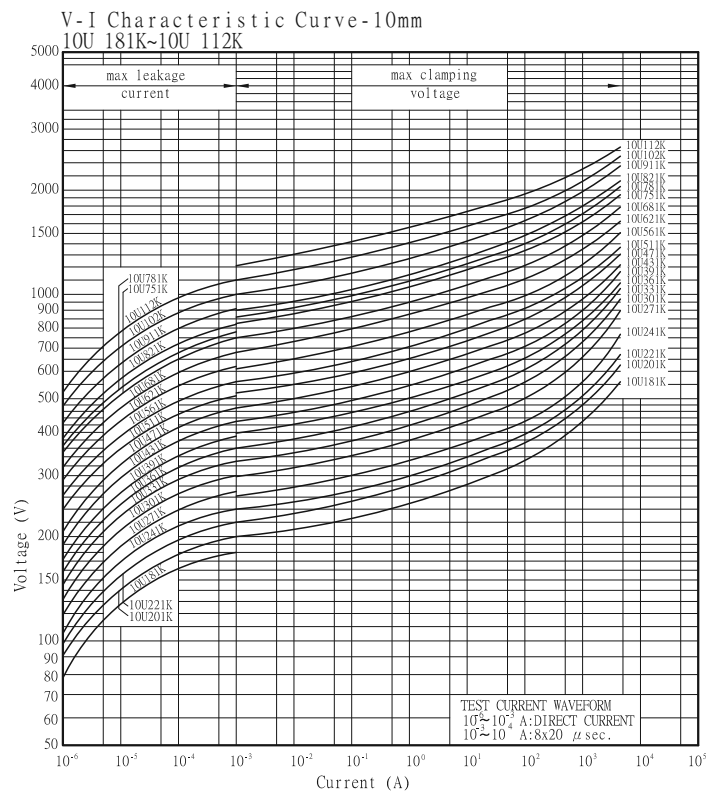
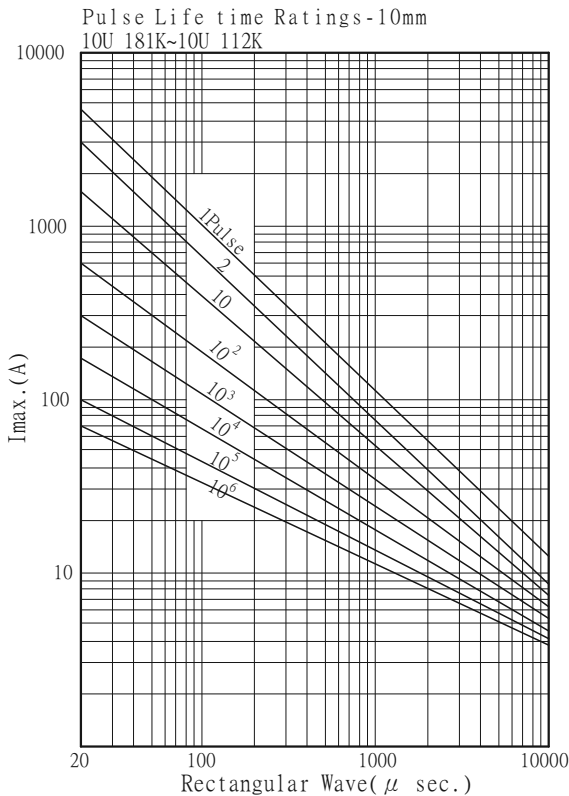



RATING AND CHARACTERISTICS

Ultra Surge Varistors - 14mm

Part No.	Varistor Voltage at 1mA		Maximum Allowable Voltage		Maximum Clamping Voltage		Withstanding Surge Current (8/20us)	Nominal Discharge Current (8/20us)	Rated Wattage	Energy (10/1000us)	Certification		
	DC (V)	Tolerance	AC rms (V)	DC (V)	V@ic (V)	ic (A)					1 Time (A)	In (KA)	(W)
JVR 14U 181K	180	±10%	115	150	300	100	8000	3	0.6	60.0	★	★	★
JVR 14U 201K	200	±10%	130	170	340	100	8000	3	0.6	82.0	★	★	★
JVR 14U 221K	220	±10%	140	180	360	100	8000	3	0.6	90.0	★	★	★
JVR 14U 241K	240	±10%	150	200	395	100	8000	3	0.6	98.0	★	★	★
JVR 14U 271K	270	±10%	175	225	455	100	8000	3	0.6	116.0	★	★	★
JVR 14U 301K	300	±10%	195	250	505	100	8000	3	0.6	128.0	★	★	★
JVR 14U 331K	330	±10%	210	275	550	100	8000	3	0.6	140.0	★	★	★
JVR 14U 361K	360	±10%	230	300	595	100	8000	3	0.6	158.0	★	★	★
JVR 14U 391K	390	±10%	250	320	650	100	8000	3.0	0.6	170.0	★	★	★
JVR 14U 431K	430	±10%	275	350	710	100	8000	3.0	0.6	185.0	★	★	★
JVR 14U 471K	470	±10%	300	385	775	100	8000	3.0	0.6	205.0	★	★	★
JVR 14U 511K	510	±10%	320	418	842	100	8000	3.0	0.6	220.0	★	★	★
JVR 14U 561K	560	±10%	350	460	920	100	8000	3.0	0.6	240.0	★	★	★
JVR 14U 621K	620	±10%	385	505	1025	100	8000	3.0	0.6	250.0	★	★	★
JVR 14U 681K	680	±10%	420	560	1120	100	8000	3.0	0.6	260.0	★	★	★
JVR 14U 751K	750	±10%	460	615	1240	100	8000	3.0	0.6	270	★	★	★
JVR 14U 781K	780	±10%	485	640	1290	100	8000	3.0	0.6	274	★	★	★
JVR 14U 821K	820	±10%	510	670	1355	100	8000	3.0	0.6	280.0	★	★	★
JVR 14U 911K	910	±10%	550	745	1500	100	8000	3.0	0.6	295	★	★	★
JVR 14U 102K	1000	±10%	625	825	1650	100	8000	3.0	0.6	335	★	★	★
JVR 14U 112K	1100	±10%	680	895	1815	100	8000	3.0	0.6	360	★	★	★

過電壓保護

Pulse Life time Ratings - 14mm  
14U 181K~14U 112K

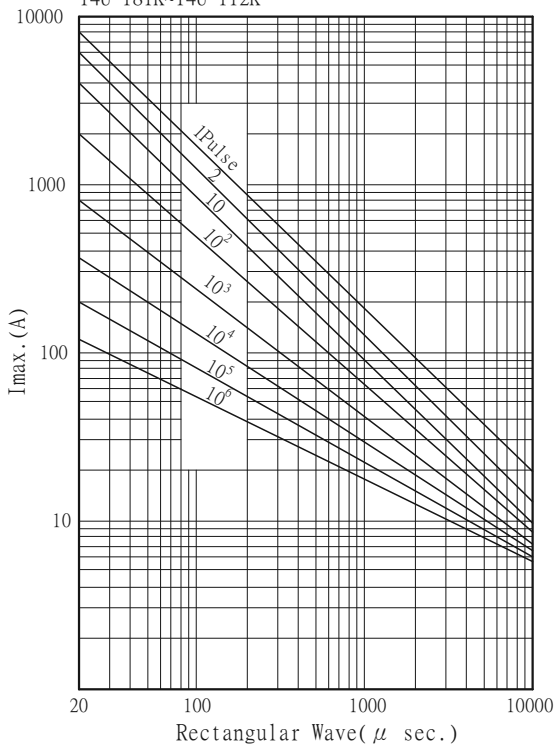

V-I Characteristic Curve - 14mm  
14U 181K~14U 112K

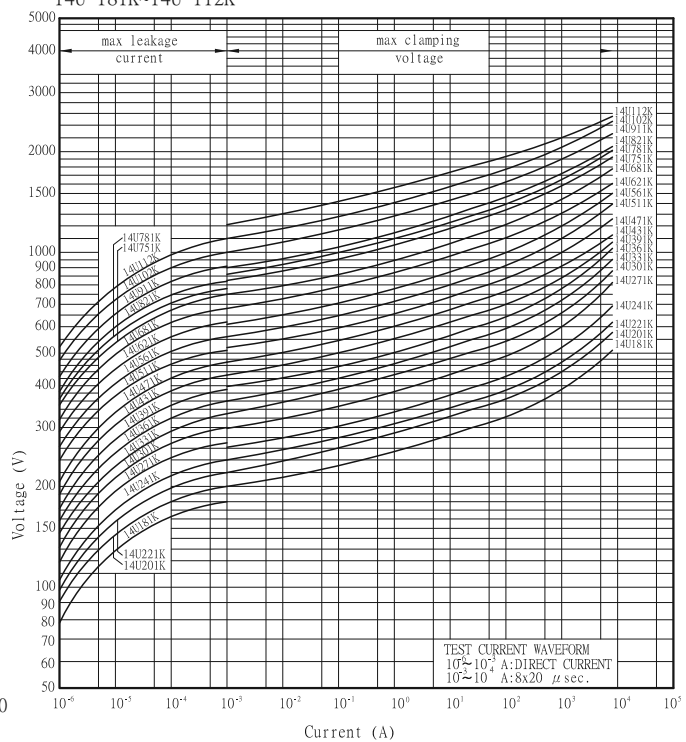

All specification is base on datasheets and subject to change without notice.



**RATING AND CHARACTERISTICS**  
Ultra Surge Varistors - 20mm

Part No.	Varistor Voltage at 1mA		Maximum Allowable Voltage		Maximum Clamping Voltage		Withstanding Surge Current (8/20us)	Nominal Discharge Current (8/20us)	Rated Wattage	Energy (10/1000us)	Certification		
	DC (V)	Tolerance	AC rms (V)	DC (V)	V@ ic (V)	ic (A)	1 Time (A)	In (KA)	(W)	(J)	UL	CE	CCC
JVR 20U 181K	180	±10%	115	150	300	100	13000	5	1	152.0	★	★	★
JVR 20U 201K	200	±10%	130	170	340	100	13000	5	1	175.0	★	★	★
JVR 20U 221K	220	±10%	140	180	360	100	13000	5	1	185.0	★	★	★
JVR 20U 241K	240	±10%	150	200	395	100	13000	5	1	198.0	★	★	★
JVR 20U 271K	270	±10%	175	225	455	100	13000	5	1	220.0	★	★	★
JVR 20U 301K	300	±10%	195	250	505	100	13000	5	1	245.0	★	★	★
JVR 20U 331K	330	±10%	210	275	550	100	13000	5	1	268.0	★	★	★
JVR 20U 361K	360	±10%	230	300	595	100	13000	5	1	315.0	★	★	★
JVR 20U 391K	390	±10%	250	320	650	100	13000	5.0	1	350.0	★	★	★
JVR 20U 431K	430	±10%	275	350	710	100	13000	5.0	1	380.0	★	★	★
JVR 20U 471K	470	±10%	300	385	775	100	13000	5.0	1	405.0	★	★	★
JVR 20U 511K	510	±10%	320	418	842	100	13000	5.0	1	445.0	★	★	★
JVR 20U 561K	560	±10%	350	460	920	100	13000	5.0	1	475.0	★	★	★
JVR 20U 621K	620	±10%	385	505	1025	100	13000	5.0	1	490.0	★	★	★
JVR 20U 681K	680	±10%	420	560	1120	100	13000	5.0	1	500.0	★	★	★
JVR 20U 751K	750	±10%	460	615	1240	100	13000	5.0	1	525	★	★	★
JVR 20U 781K	780	±10%	485	640	1290	100	13000	5.0	1	530	★	★	★
JVR 20U 821K	820	±10%	510	670	1355	100	13000	5.0	1	545.0	★	★	★
JVR 20U 911K	910	±10%	550	745	1500	100	13000	5.0	1	595	★	★	★
JVR 20U 102K	1000	±10%	625	825	1650	100	13000	5.0	1	650	★	★	★
JVR 20U 112K	1100	±10%	680	895	1815	100	13000	5.0	1	720	★	★	★

過電壓保護

Pulse Life time Ratings -20mm  
20U 181K~20U 112K

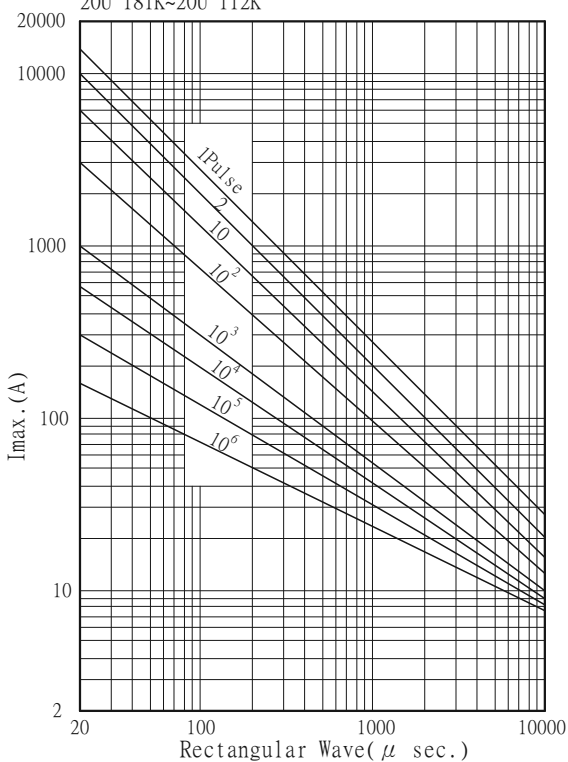

V-I Characteristic Curve -20mm  
20U 181K~20U 112K

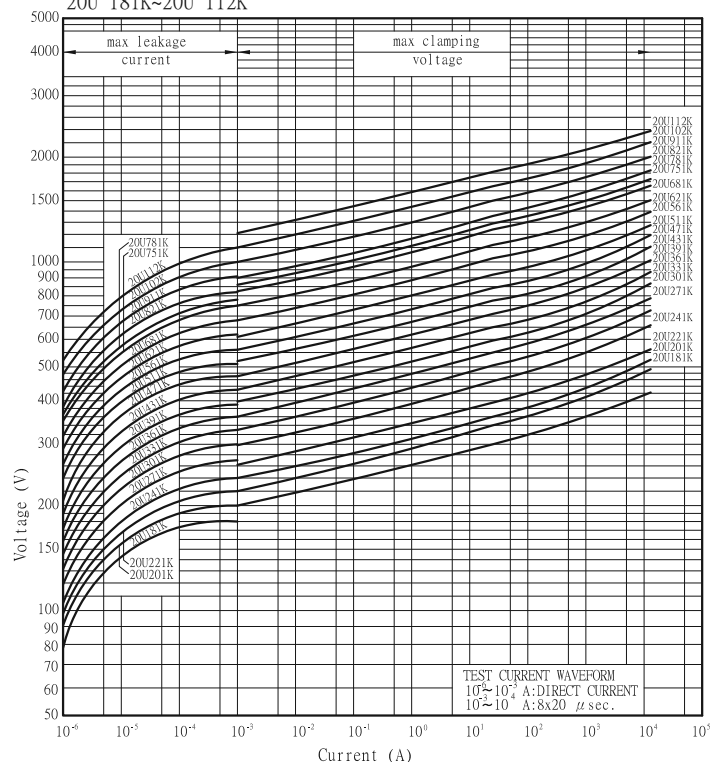



JOYIN CO., LTD

Metal Oxide Varistor

Reliability-JVR

Test description	Standard	Test condition	Test requirement						
Tensile Strength of Terminals	IEC60068-2-21	After gradually applying the load specified below and keeping the unit fixed for 10±1 seconds. <table border="1"> <tr> <td>Terminal diameter (mm)</td> <td>Force (Kg)</td> </tr> <tr> <td>0.5 &lt; d ≤ 0.8</td> <td>1.0</td> </tr> <tr> <td>0.8 &lt; d ≤ 1.25</td> <td>2.0</td> </tr> </table>	Terminal diameter (mm)	Force (Kg)	0.5 < d ≤ 0.8	1.0	0.8 < d ≤ 1.25	2.0	No visible damage ΔVb% ≤ ±5%
Terminal diameter (mm)	Force (Kg)								
0.5 < d ≤ 0.8	1.0								
0.8 < d ≤ 1.25	2.0								
Bending Strength of Terminals	IEC60068-2-21	Hold specimen and apply the force specified below to each lead. Bend the specimen to 90°, then return to the original position. Repeat the procedure in the opposite direction. <table border="1"> <tr> <td>Terminal diameter (mm)</td> <td>Force (Kg)</td> </tr> <tr> <td>0.5 &lt; d ≤ 0.8</td> <td>0.5</td> </tr> <tr> <td>0.8 &lt; d ≤ 1.25</td> <td>1.0</td> </tr> </table>	Terminal diameter (mm)	Force (Kg)	0.5 < d ≤ 0.8	0.5	0.8 < d ≤ 1.25	1.0	No visible damage ΔVb% ≤ ±5%
Terminal diameter (mm)	Force (Kg)								
0.5 < d ≤ 0.8	0.5								
0.8 < d ≤ 1.25	1.0								
Vibration	IEC60068-2-6	Frequency range : 10Hz~55Hz Amplitude : 0.75mm or 98 m/s <sup>2</sup> Direction : 3 mutually perpendicular directions, 2hrs each.	No visible damage ΔVb% ≤ ±5%						
Solderability	IEC60068-2-20	Bath temperature : 245±3°C Immersion time : 3±0.3 sec	At least 95% of terminal electrode is covered by new solder						
Resistance to soldering heat	IEC60068-2-20	Bath temperature : 260±3°C Immersion time : 10±1 sec (5N series 5±0.5s)	No visible damage ΔVb(1mA) ≤ ±5%						
Voltage Proof	IEC61051-1	The specified voltage is applied between both terminals of the component connected together for 1 minute . <table border="1"> <tr> <td>2500Vrms(AC)</td> <td>Test Voltage(AC)</td> </tr> </table>	2500Vrms(AC)	Test Voltage(AC)	No visible damage				
2500Vrms(AC)	Test Voltage(AC)								
Rapid change of temperature	IEC60068-2-14	Temperature cycle shall be repeated 5 cycles 1. -40±3°C keeping 30±3min 2. Room temperature keeping 5±3min 3. 125±2°C keeping 30±3min 4. Room temperature keeping 5±3min	No visible damage ΔVb% ≤ ±5%						
Damp heat load	IEC60068-2-78	Temperature 40±2°C R.H.90~95% and the maximum Allowable voltage for 1000±24 hours	No visible damage ΔVb% ≤ ±10%						
Damp heat	IEC60068-2-78	Temperature 40±2°C R.H.90~95% for 1000±24 hours	No visible damage ΔVb% ≤ ±5%						
High temperature load	MIL-STD-202 Method 108	After being continuously applied the max allowable voltage at 85±2°C for 1000±24 hours	No visible damage ΔVb% ≤ ±10%						
High temperature storage	IEC60068-2-2	125±5°C for 1000±24 hours	No visible damage ΔVb% ≤ ±5%						
Low temperature storage	IEC60068-2-1	-40±2°C for 1000±24 hours	No visible damage ΔVb% ≤ ±5%						
Varistor Voltage Temp.Coefficient	Specification Standard	Measure V1mA at -40°C、25°C、125°C	-0.05 ≤ TC ≤ 0.05(%/°C)						
8/20μs Surge Life	IEC61051-1	8/20μs waveform, 10 surge current, unipolar, interval 30 secs, amplitude corresponding to max. surge current derating curves for 20μs.	No visible damage ΔVb% ≤ ±10%						
10/1000μs Surge Life	IEC61051-1	10/1000μs waveform, 10 surge current, unipolar, interval 2 mins, amplitude corresponding to max. surge current derating curves for 1000μs.	No visible damage ΔVb% ≤ ±10%						

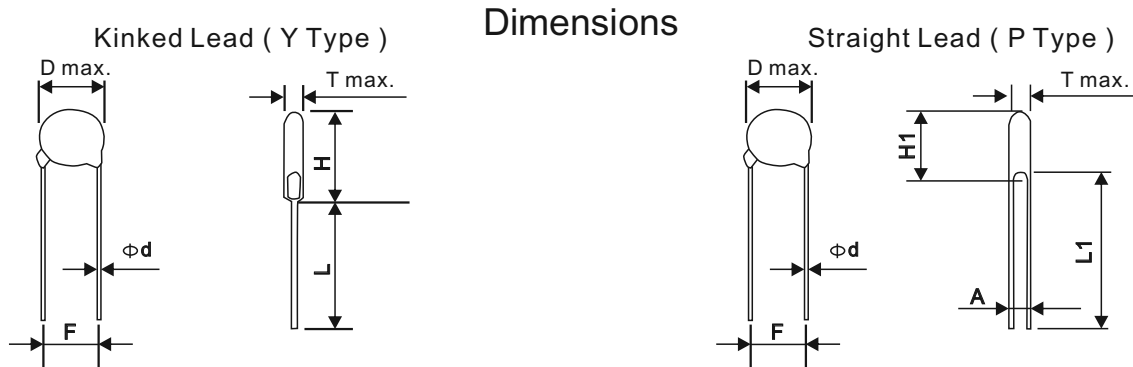

### Dimensions

Dimensions Table

unit : mm

Diameter	5mm	7mm	10mm	14mm	20mm	25mm
D max.	7.5	9.0	12.5	16.5	23	29
d ± 0.05	0.6	0.6	0.8	0.8	1.0	1.0
F ± 1.0	5.0	5.0	7.5	7.5	10.0	10.0
H max.	11.0	12.5	17/*19	22/*23	28/*29	36
L1 min.	25.0	25.0	25.0	25.0	25.0	25.0
L min.	24.0	24.0	24.0	24.0	24.0	20.0

\*Just for 182K

Table of Tmax, A&H1 max.

unit : mm

Diameter TypeNo.	5mm			7mm			10mm			14mm			20mm			25mm		
	T max.	A± 0.8	H1max.	T max.	A± 0.8	H1max.	T max.	A± 0.8	H1max.	T max.	A± 0.8	H1max.	T max.	A± 0.8	H1max.	T max.	A± 0.8	H1max.
180M	3.9	0.8	10.5	3.9	0.8	12.0	4.3	0.8	15.0	4.3	0.9	19.5	/	/	/	/	/	/
220M/L	4.1	0.9	10.5	4.1	0.9	12.0	4.5	0.9	15.0	4.5	1.0	19.5	4.9	1.0	26.5	/	/	/
270M/K	4.3	0.9	10.5	4.3	0.9	12.0	4.7	0.9	15.0	4.7	1.0	19.5	5.1	1.1	26.5	/	/	/
330M/K	4.5	1.0	10.5	4.5	1.0	12.0	4.9	1.0	15.0	4.9	1.2	19.5	5.3	1.2	26.5	/	/	/
390L/K	4.5	1.2	10.5	4.5	1.2	12.0	5.1	1.2	15.0	5.1	1.4	19.5	5.4	1.4	26.5	/	/	/
470L/K	4.8	1.2	10.5	4.8	1.2	12.0	5.3	1.2	15.0	5.4	1.4	19.5	5.6	1.4	26.5	/	/	/
560L/K	4.8	1.4	10.5	4.8	1.4	12.0	5.5	1.4	15.0	5.6	1.6	19.5	5.6	1.6	26.5	/	/	/
680L/K	5.1	1.7	10.5	5.1	1.7	12.0	5.7	1.6	15.0	5.6	1.9	19.5	5.9	1.9	26.5	/	/	/
820K	3.8	0.8	10.5	3.8	0.8	12.0	4.3	0.8	15.0	4.3	1.0	19.5	4.7	1.1	26.5	/	/	/
101K	3.9	0.8	10.5	3.9	0.8	12.0	4.4	0.8	15.0	4.5	1.0	19.5	4.9	1.2	26.5	/	/	/
121K	4.1	0.9	10.5	4.1	0.9	12.0	4.5	0.9	15.0	4.6	1.1	19.5	5.1	1.3	26.5	/	/	/
151K	4.5	1.2	10.5	4.5	1.2	12.0	4.9	1.2	15.0	5.0	1.4	19.5	5.4	1.6	26.5	/	/	/
181K	3.9	1.0	10.5	3.9	1.0	12.0	4.3	1.0	15.0	4.3	1.2	19.5	5.0	1.4	26.5	/	/	/
201K	4.0	1.0	10.5	4.0	1.0	12.0	4.4	1.0	15.0	4.4	1.2	19.5	5.1	1.4	26.5	5.4	2.5	35
221K	4.0	1.1	10.5	4.0	1.1	12.0	4.4	1.1	15.0	4.4	1.3	19.5	5.2	1.5	26.5	5.6	2.6	35
241K	4.2	1.1	10.5	4.2	1.3	12.0	4.6	1.3	15.0	4.6	1.5	19.5	5.3	1.7	26.5	5.7	2.8	35
271K	4.4	1.3	10.5	4.4	1.4	12.0	4.8	1.4	15.0	4.8	1.5	19.5	5.5	1.9	26.5	6.0	3.0	35
301K	4.4	1.3	10.5	4.4	1.5	12.0	4.8	1.6	15.0	4.8	1.7	19.5	5.7	2.1	26.5	6.3	3.2	35
331K	4.5	1.3	10.5	4.5	1.5	12.0	4.9	1.6	15.0	4.9	1.7	19.5	5.8	2.1	26.5	6.6	3.4	35
361K	4.7	1.8	10.5	4.6	1.9	12.0	5.0	1.9	15.0	5.0	2.1	19.5	6.0	2.3	26.5	6.8	3.6	35
391K	4.8	2.0	11.0	4.8	2.0	12.5	5.2	2.2	15.0	5.2	2.2	19.5	6.2	2.4	26.5	7.1	3.9	35
431K	5.1	2.1	11.0	5.1	2.0	12.5	5.5	2.5	15.0	5.5	2.5	19.5	6.6	2.7	26.5	7.2	3.3	35
471K	5.2	2.2	11.0	5.2	2.3	12.5	5.6	2.6	15.0	5.6	2.7	19.5	6.8	2.9	27.0	7.4	3.5	35
511K	5.6	2.5	11.5	5.6	2.5	12.5	5.8	3.1	15.0	5.8	3.1	20.0	7.0	3.3	27.0	7.6	3.8	35
561K	5.7	2.8	11.5	5.7	2.8	12.5	6.1	3.4	15.0	6.1	3.4	20.0	7.3	3.6	27.0	7.9	4.0	35
621K	6.0	3.1	11.5	6.0	3.1	12.5	6.4	4.0	15.0	6.4	3.8	20.0	7.6	4.1	27.0	8.2	4.4	35
681K	6.3	3.4	11.5	6.3	3.4	12.5	6.8	4.4	15.0	6.8	4.1	20.0	8.0	4.4	27.0	8.3	4.7	35
751K	6.7	3.7	11.5	6.8	3.7	12.5	7.2	4.4	15.0	7.2	4.3	20.0	8.4	4.5	27.0	8.7	5.0	35
781K	/	/	/	7.0	3.9	12.5	7.3	4.6	15.0	7.3	4.6	20.0	8.6	4.8	27.0	8.9	5.2	35
821K	/	/	/	7.2	4.1	12.5	7.6	4.6	15.0	7.6	4.6	20.0	8.8	4.8	27.0	9.1	5.4	35
911K	/	/	/	/	/	/	8.2	5.4	16.0	8.2	5.4	20.5	9.3	5.7	27.0	9.6	5.9	35
102K	/	/	/	/	/	/	8.5	5.4	16.0	8.6	5.6	20.5	9.9	5.8	27.0	/	/	/
112K	/	/	/	/	/	/	9.1	5.7	16.0	9.1	6.1	20.5	10.3	6.3	27.0	/	/	/
122K	/	/	/	/	/	/	9.9	6.3	17.0	10.0	6.7	21.0	11.3	6.9	27.5	/	/	/
142K	/	/	/	/	/	/	10.7	7.4	17.5	10.9	7.8	21.5	12.8	8.0	28.0	/	/	/
162K	/	/	/	/	/	/	11.5	8.6	17.5	11.8	9.0	21.5	13.0	9.2	28.5	/	/	/
182K	/	/	/	/	/	/	12.6	9.8	17.5	12.8	10.2	21.5	13.5	10.4	29.0	/	/	/

過電壓保護

### Tape and Reel Dimensions

1/2" pitch

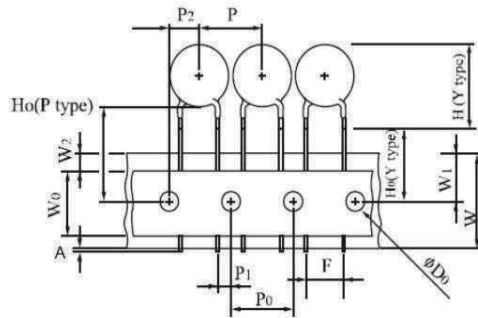

1.0" pitch

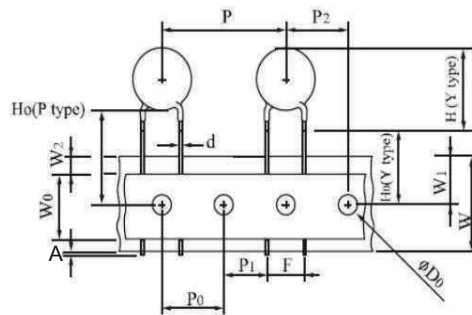

Symbols	Item	5 / 7 mm	10 / 14 mm	20 mm
A	Cut out length	1.1 mm max.	1.1 mm max.	
H (Y type)	Height of Top	See H max. table		
H0(Y type)	Height to seating plane	16.0 ± 0.5 mm (* ± 1.0 mm)	16.0 ± 0.5 mm(* ± 1.0 mm)	
H0(P type)	Height of component from hole center	16.0 ~ 21.0 mm	16.0 ~ 21.0 mm	
Δh	Front to back deviation	0 ± 2.0 mm	0 ± 2.0 mm	
W	Carrier tape width	18 +1.0 / -0.5 mm	18 +1.0 / -0.5 mm	
W0	Hold downtape width	10.0 mm	12.0 mm	
W1	Sprocket hole position	9.0 +0.75 / -0.5 mm	9.0 +0.75 / -0.5 mm	
W2	Adhesive tape position	3.0 mm max.	3.0 mm max.	
F	Component lead spacing	5.0 ± 1.0 mm	7.5 ± 1.0 mm	10.0 ± 1.0 mm
P	Pitch of component	12.7 ± 1.0 mm	25.4 ± 1.0 mm	
P0	Sprocket hole pitch	12.7 ± 0.3 mm	12.7 ± 0.3 mm	
P1	Lead length from hole center to lead	3.85 ± 0.7 mm	8.95 ± 0.7 mm	7.7 ± 0.7 mm
P2	Length from hole center to disk center	6.35 ± 1.3 mm	12.7 ± 1.3 mm	
D0	Sprocket hole diameter	4.0 ± 0.2 mm	4.0 ± 0.2 mm	
d	Lead wire diameter	0.6 ± 0.05 mm	0.8 ± 0.05 mm	1.0 ± 0.05 mm
T	Disk thickness	See Tmax. table	See T max. table	
t1	Total thickness tape	0.7 ± 0.05 mm	0.7 ± 0.05 mm	
t2	Total thickness	1.6 mm max.	1.8 mm max.	





## Marking & packaging

### MARKING

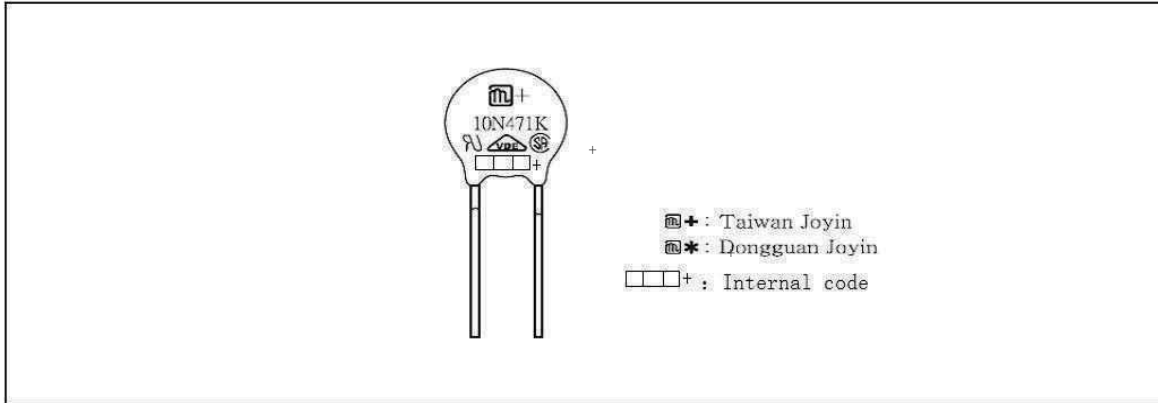

### PACKAGING

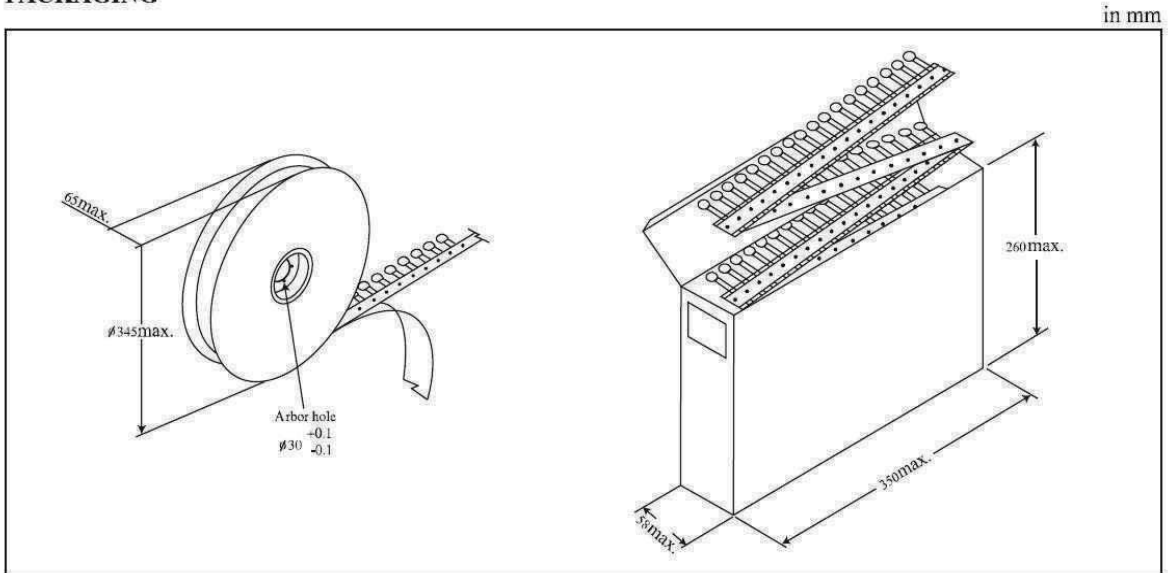

### Quantity per Packing Unit

in Pcs

Part No.	Series			5 mm			7 mm			10 mm			14 mm			20 mm			25 mm	
	Bulk (Box)	Reel	Ammo	Bulk (Box)	Reel	Ammo	Bulk (Box)	Reel	Ammo	Bulk (Box)	Reel	Ammo	Bulk (Box)	Reel	Ammo	Bulk (Box)	Reel	Ammo	Bulk (Box)	
180M~ 470K	5000	1500	1500	5000	1500	1500	2500	1000	500	1500	750	500	750	500	500	750	500	500	500	-
560K ~ 680K	5000	1500	1000	5000	1500	1000	2500	1000	500	1500	750	500	750	500	750	500	500	500	500	-
820K ~ 391K	5000	1500	1500	5000	1500	1500	2500	1000	500	1500	750	500	750	500	750	500	500	500	750	750
431K ~ 471K	5000	1500	1000	5000	1000	1000	2000	750	500	1500	750	500	750	500	750	500	500	500	750	750
511K ~ 821K	4000	1000	1000	4000	1000	1000	1500	500	500	750	500	500	450	500	500	450	500	500	450	450
911K ~ 122K	-	-	-	-	-	-	1500	500	350	750	500	350	450	-	-	450	-	-	-	450
142K ~ 182K	-	-	-	-	-	-	750	-	-	450	-	-	300	-	-	300	-	-	-	-

Packaging	Bulk (Box)	Reel	Reel (14 mm, 20mm)	Ammo (5 mm, 7 mm)	Ammo (10 mm, 14 mm)	Ammo (20 mm)
Box size (mm)	290×155×110	350×350×105	346×346×72	335×245×43	347×246×50	348×255×60
Carton size (mm)	328×310×250	370×370×590	370×370×468	515×354×258	515×364×246	535×365×275
One carton with	4 Boxes	5 Boxes (10 reels)	6 Boxes (6 reels)	10 Boxes	8 Boxes	8 Boxes