

Inductors for Power over Coaxial (PoC)

Power injection choke, EIA1210

Series/Type: **ADM32FSC**
Date: February 2021
Rev: 01

Inductors for Power over Coaxial (PoC)

Power injection choke, EIA1210

ADM32FSC

Rated voltage: 42 V AC / 80 V DC

Rated inductance: 10 ... 22 μ H

Construction

- Metal I-core, Ferrite shielding
- Winding: enamel copper wire
- Winding welded to terminals



Features

- Temperature range up to +150 °C
- Suitable for lead-free reflow soldering as referenced in JEDEC J-STD 020D
- Qualified according to AEC-Q200
- RoHS-compatible

Applications

- Automotive Electronics
- Power over Coaxial (PoC)

Terminals

One-sided tinned terminals

- Base material CuSn6
- Layer composition Ni, Sn
- Lead-free tinned

Marking

- Marking on component:
L value (in μ H, coded), date code, pin1 marking
- Minimum data on reel:
Lot number, part number, date of packing

Delivery mode and packing unit

- 12 mm blister tape, wound on 330 mm \varnothing reel
- Packing unit: 6.000 pcs / reel

Dimensional drawing

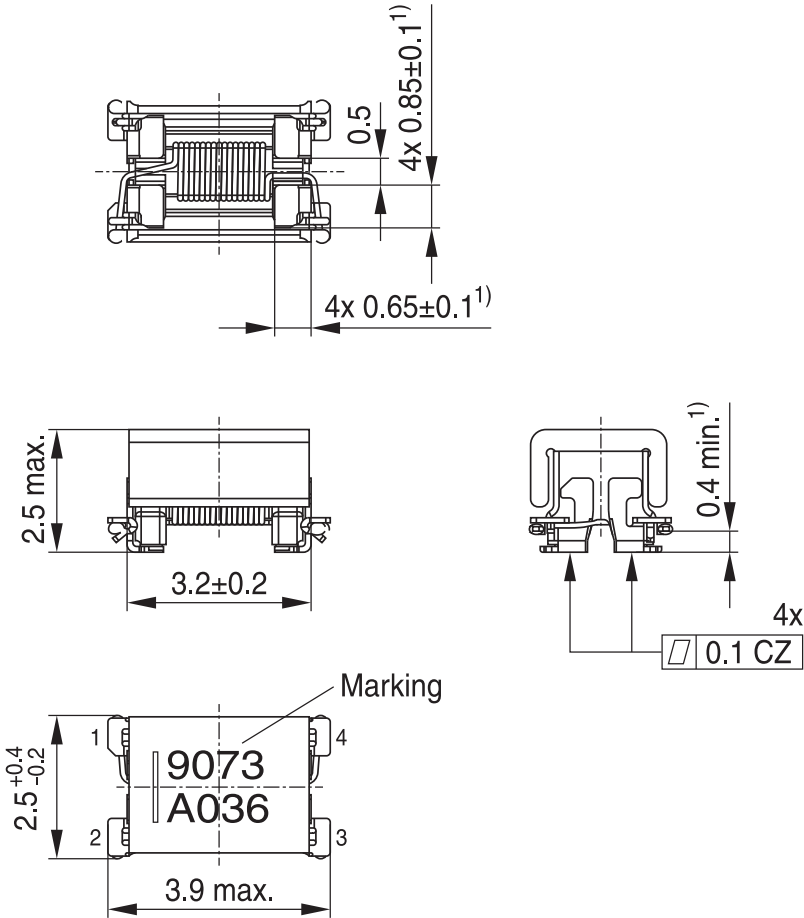

¹⁾ Soldering area

IND1748-F-E

Dimensions in mm

Inductors for Power over Coaxial (PoC)

Power injection choke, EIA1210

ADM32FSC

Layout recommendation and pin configuration

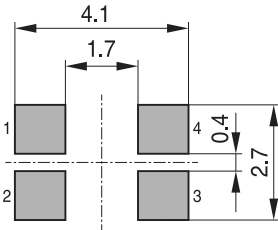

1-2 and 3-4 to be joined in PCB

IND1749-G-E

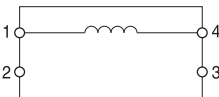

No polarity

1-2 and 3-4 to be joined in PCB

IND1750-H-E



IND1751-I

Taping and packing

Blister tape

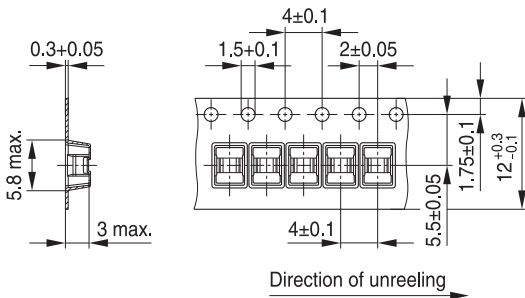

IND1752-J-E

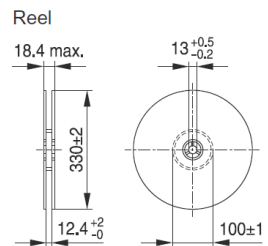

IND1526-N

Inductors for Power over Coaxial (PoC)
Power injection choke, EIA1210
ADM32FSC
Technical data and measuring conditions

Rated inductance L_R	Measured with Keysight E4980A (or equivalent) at 100 kHz, 0.1 mA, +23 °C \pm 3 °C
Inductance tolerance	\pm 20% at +23 °C \pm 3 °C
DC resistance R_{DC}	Measured at +23°C \pm 3°C
Self-resonant frequency f_{res}	Measured with Keysight E4990A (or equivalent), +23 °C \pm 3 °C
Saturation current I_{DC1}	Based on the inductance change rate (30% below the initial value)
Rated current I_{DC2}	Based on the temperature increase (temperature increase +40 °C / +25 °C by self-heating) Ambient temperature: +25 °C / +105 °C / +125 °C I_{DC2} are reference values evaluated under consideration of generic multilayer PCB
Weight	Approx. 0.08 g

Characteristics and ordering codes

L_R	$R_{DC,max}$	$f_{res,typ}$	$I_{DC1,typ}$ @ T_{amb} : +25 °C	$I_{DC2,typ}$ @ T_{amb} + temp. increase in °C			Internal code	Ordering code
				+25 +40	+105 +40	+125 +25		
μ H	Ω	MHz	mA	mA				
10	0.42	52	1060	880	790	630	B82782N1103H100	ADM32FSC-100M
22	0.60	33	740	740	680	530	B82782N1223H100	ADM32FSC-220M

Inductors for Power over Coaxial (PoC)

Power injection choke, EIA1210

ADM32FSC

Impedance versus frequency (typical curves)

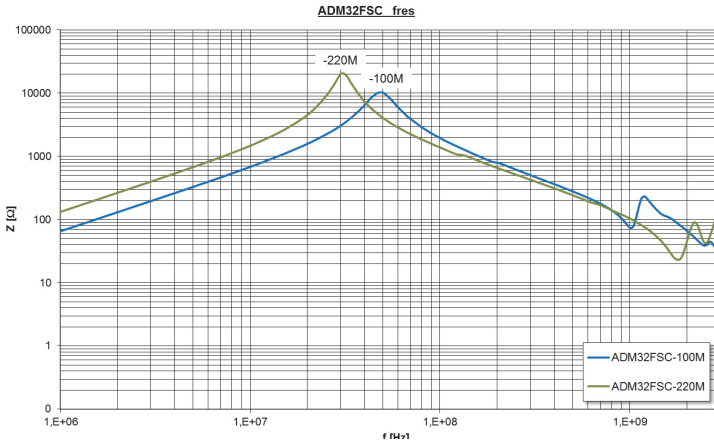

Saturation current I_{DC1} (typical curves)

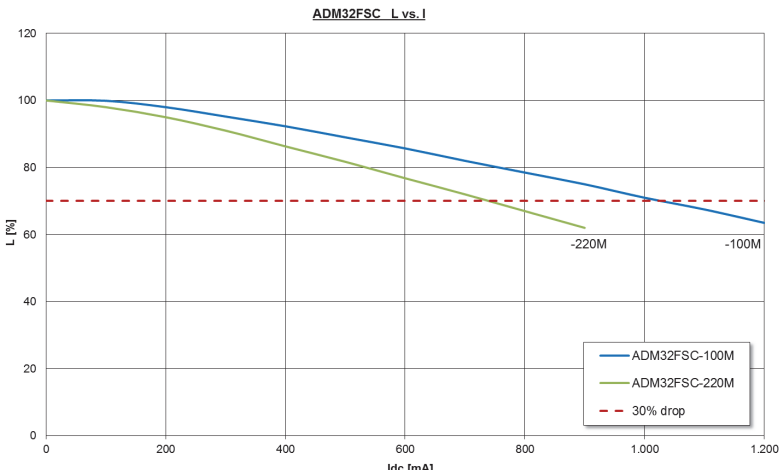

Inductors for Power over Coaxial (PoC)

Power injection choke, EIA1210

ADM32FSC

Rated current I_{DC2} (typical curves at ambient temp. +25 °C)

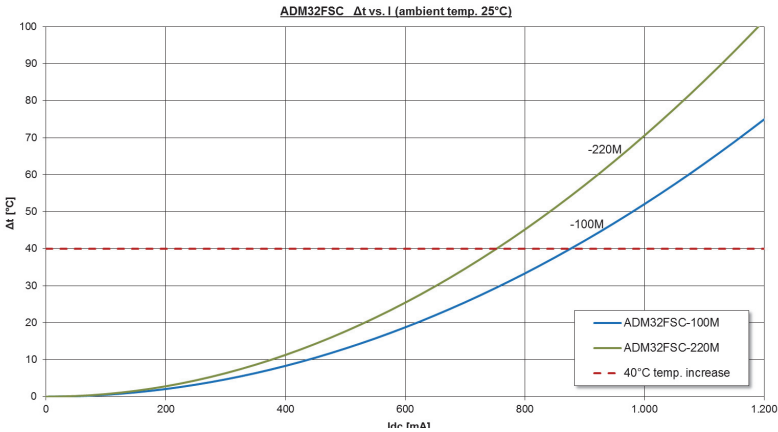

Rated current I_{DC2} (typical curves at ambient temp. +125 °C)

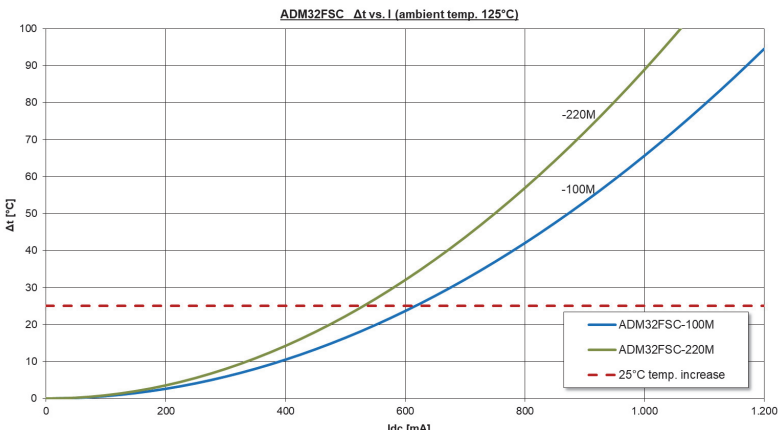

Cautions and warnings

- Please note the recommendations in our Inductors data book (latest edition) and in the data sheets.
 - Particular attention should be paid to the derating curves given there.
 - The soldering conditions should also be observed. Temperatures quoted in relation to wave soldering refer to the pin, not the housing.
- If the components are to be washed varnished it is necessary to check whether the washing varnish agent that is used has a negative effect on the wire insulation, any plastics that are used, or on glued joints. In particular, it is possible for washing varnish agent residues to have a negative effect in the long-term on wire insulation.

Washing processes may damage the product due to the possible static or cyclic mechanical loads (e.g. ultrasonic cleaning). They may cause cracks to develop on the product and its parts, which might lead to reduced reliability or lifetime.
- The following points must be observed if the components are potted in customer applications:
 - Many potting materials shrink as they harden. They therefore exert a pressure on the plastic housing or core. This pressure can have a deleterious effect on electrical properties, and in extreme cases can damage the core or plastic housing mechanically.
 - It is necessary to check whether the potting material used attacks or destroys the copper wire, wire insulation, plastics or glue.
 - The effect of the potting material can change the high-frequency behaviour of the components.
 - Many coating materials have a negative effect (chemically and mechanically) on the winding wires, insulation materials and connecting points. Customers are always obligated to determine whether and to what extent their coating materials influence the component. Customers are responsible and bear all risk for the use of the coating material. TDK Electronics does not assume any liability for failures of our components that are caused by the coating material.
- Ferrites are sensitive to direct impact. This can cause the core material to flake, or lead to breakage of the core.
- Even for customer-specific products, conclusive validation of the component in the circuit can only be carried out by the customer.

Display of ordering codes for TDK Electronics products

The ordering code for one and the same product can be represented differently in data sheets, data books, other publications, on the company website, or in order-related documents such as shipping notes, order confirmations and product labels. **The varying representations of the ordering codes are due to different processes employed and do not affect the specifications of the respective products.** Detailed information can be found on the Internet under www.tdk-electronics.tdk.com/orderingcodes.

Important notes

The following applies to all products named in this publication:

1. Some parts of this publication contain **statements about the suitability of our products for certain areas of application**. These statements are based on our knowledge of typical requirements that are often placed on our products in the areas of application concerned. We nevertheless expressly point out **that such statements cannot be regarded as binding statements about the suitability of our products for a particular customer application**. As a rule we are either unfamiliar with individual customer applications or less familiar with them than the customers themselves. For these reasons, it is always ultimately incumbent on the customer to check and decide whether a product with the properties described in the product specification is suitable for use in a particular customer application.
2. We also point out that **in individual cases, a malfunction of electronic components or failure before the end of their usual service life cannot be completely ruled out in the current state of the art, even if they are operated as specified**. In customer applications requiring a very high level of operational safety and especially in customer applications in which the malfunction or failure of an electronic component could endanger human life or health (e.g. in accident prevention or life-saving systems), it must therefore be ensured by means of suitable design of the customer application or other action taken by the customer (e.g. installation of protective circuitry or redundancy) that no injury or damage is sustained by third parties in the event of malfunction or failure of an electronic component.
3. The warnings, cautions and product-specific notes must be observed.
4. In order to satisfy certain technical requirements, **some of the products described in this publication may contain substances subject to restrictions in certain jurisdictions (e.g. because they are classed as hazardous)**. Useful information on this will be found in our Material Data Sheets on the Internet (www.tdk-electronics.tdk.com/material). Should you have any more detailed questions, please contact our sales offices.
5. We constantly strive to improve our products. Consequently, **the products described in this publication may change from time to time**. The same is true of the corresponding product specifications. Please check therefore to what extent product descriptions and specifications contained in this publication are still applicable before or when you place an order.
 We also **reserve the right to discontinue production and delivery of products**. Consequently, we cannot guarantee that all products named in this publication will always be available.
 The aforementioned does not apply in the case of individual agreements deviating from the foregoing for customer-specific products.
6. Unless otherwise agreed in individual contracts, **all orders are subject to our General Terms and Conditions of Supply**.
7. **Our manufacturing sites serving the automotive business apply the IATF 16949 standard**. The IATF certifications confirm our compliance with requirements regarding the quality management system in the automotive industry. Referring to customer requirements and customer specific requirements ("CSR") TDK always has and will continue to have the policy of respecting individual agreements. Even if IATF 16949 may appear to support the acceptance of unilateral requirements, we hereby like to emphasize that **only requirements mutually agreed upon can and will be implemented in our Quality Management System**. For clarification purposes we like to point out that obligations from IATF 16949 shall only become legally binding if individually agreed upon.
8. The trade names EPCOS, CarXield, CeraCharge, CeraDiode, CeraLink, CeraPad, CeraPlas, CSMP, CTVS, DeltaCap, DigiSiMic, ExoCore, FilterCap, FormFit, LeaXield, MiniBlue, MiniCell, MKD, MKK, ModCap, MotorCap, PCC, PhaseCap, PhaseCube, PhaseMod, PhiCap, PowerHap, PQSine, PQvar, SIFERRIT, SIFI, SIKOREL, SilverCap, SIMDAD, SiMic, SIMID, SineFormer, SIOV, ThermoFuse, WindCap, XieldCap are **trademarks registered or pending** in Europe and in other countries. Further information will be found on the Internet at www.tdk-electronics.tdk.com/trademarks.