

Crystal Oscillators

Voltage Controlled Crystal Oscillator/SMD5032P

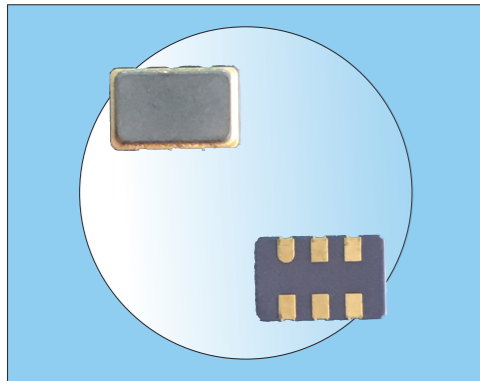

Features

- JYEG part number :JYVCD5P
- 3.3Vsupply voltage
- LVPECL output
- Tri-state function available
- Tape and reel available

TYPICAL SPECIFICATIONS

Type	VCXO SMD5032P		
Frequency Range	100.000MHZ~170MHZ(AT1)		
Frequency Stability	$\geq \pm 25\text{ppm}/\geq \pm 30\text{ppm}/\geq 50\text{ppm}$		
Operating Temperature Range	$-20^{\circ}\text{C}\sim 70^{\circ}\text{C}/-40^{\circ}\text{C}\sim 85^{\circ}\text{C}/-40^{\circ}\text{C}\sim 105^{\circ}\text{C}$		
Output Load	$50 \pm 0.5 \Omega$ (Supply VDD-2V to end point)		
Input Current	$\leq 80\text{mA}$		
Supply Voltage	$3.3\text{V} \pm 10\%$		
Start-up Time	1ms Max		
Duty Cycle	40%~60% Normal,45%~55% Tight		
Rise/Fall Time	2ns Max		
Pulling Range	$\pm 50\text{ppm}$ Min		
Control Voltage Range	0~3.3V		
Linearity	10% Max		
Output "H" Level	MIN	TYP	MAX
	2.275	2.23	2.42
Output "L" Level	MIN	TYP	MAX
	1.49	1.6	1.68
Tri-state	Pin2:0.7 VDD Min(High)or open,Output:Enable		
	Pin2:0.3 VDD Max(Low),Output:Disable		
RMS Jitter(12KHZ~20MHZ)	1.0ps Max		
Aging	$\pm 3\text{ppm}/\text{year}$ Max		
Storage Temperature Range	$-55^{\circ}\text{C}\sim 125^{\circ}\text{C}$		

Crystal Oscillators

VCXO SMD5032P(JYVCD5P)

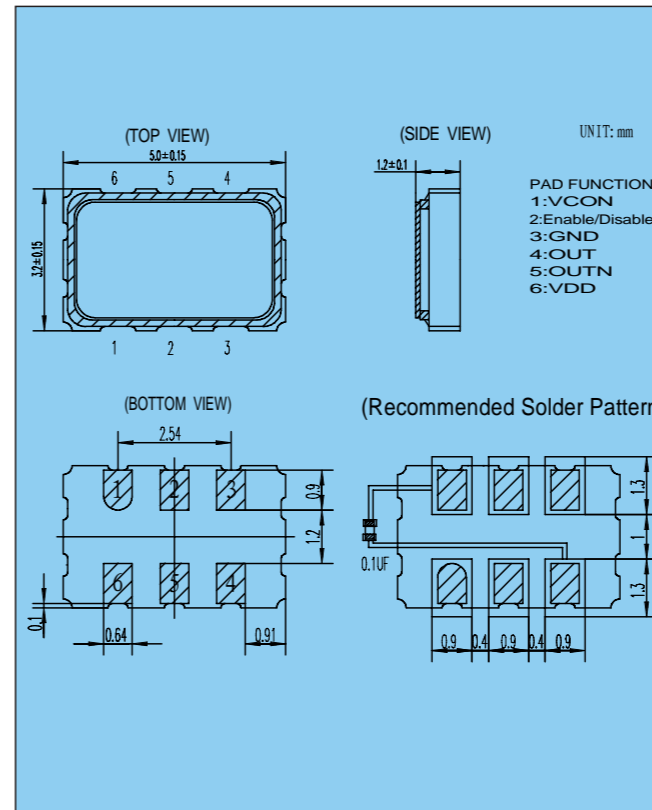

TEST CIRCUIT

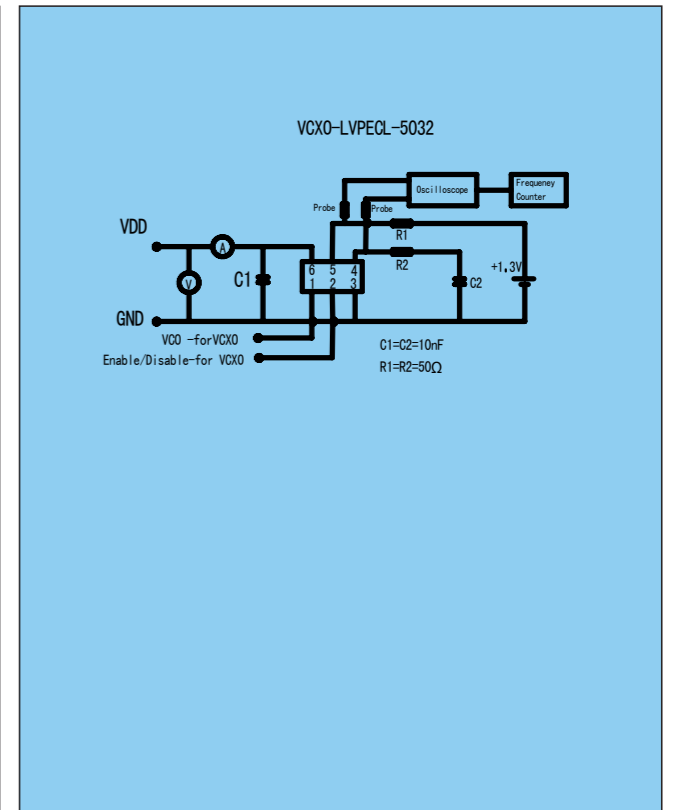

TAPE AND REEL DIMENSIONS

